

Historic, Archive Document

Do not assume content reflects current scientific knowledge, policies, or practices.

62.61

LIBRARY
RECEIVED
JUN 23 1948
U.S. Department of Agriculture

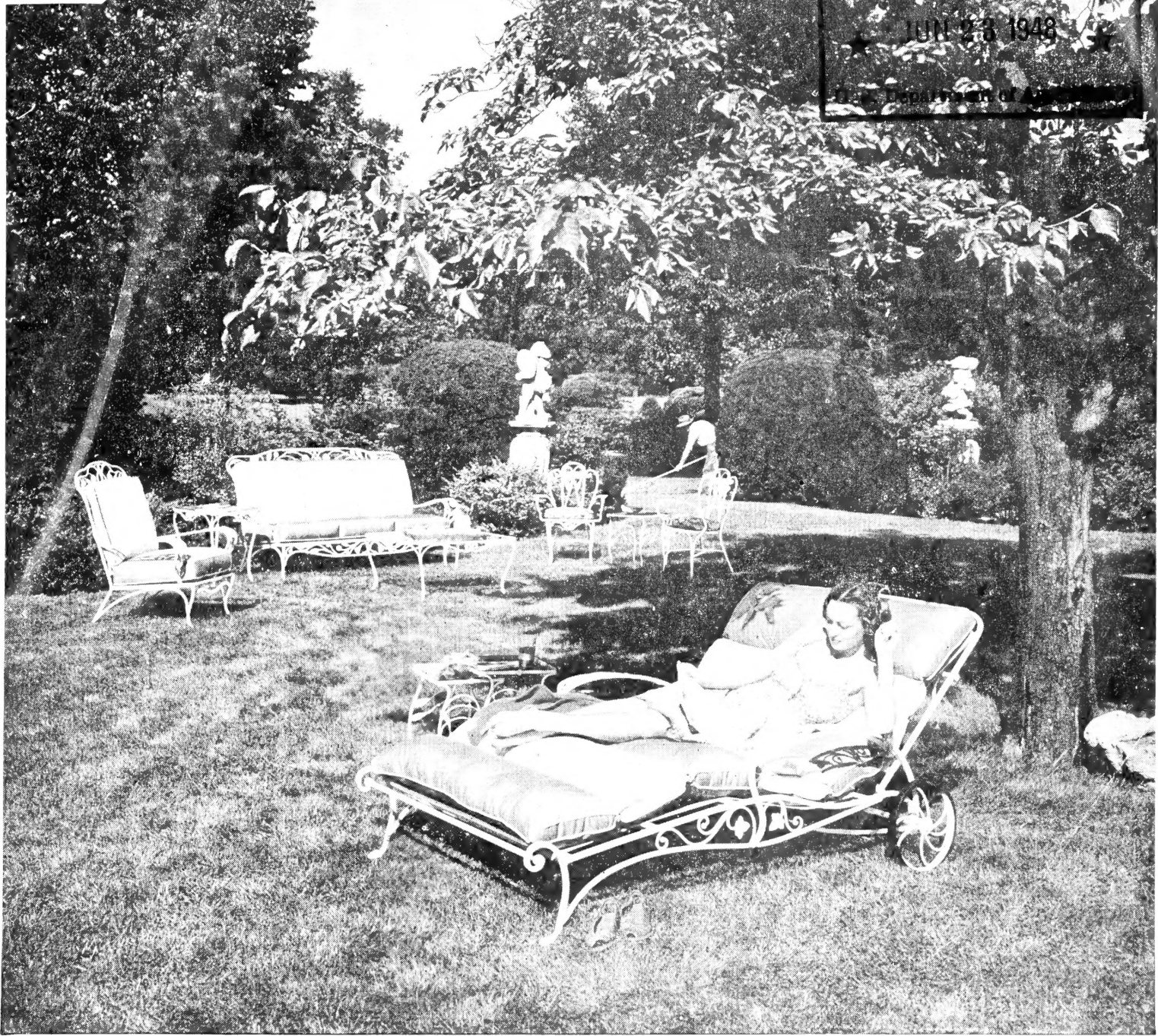

Salterini Neva-Rust Furniture. See Inside Cover

1948 SUMMER CATALOGUE

Gifts for Outdoor Living

BULBS • PLANTS • GARDEN SUPPLIES • SEEDS • EPICURE FOODS

Stumpp & Walter

132-138 Church St. (at Warren St.)

NEW YORK 8, N. Y.

SUBURBAN STORES:

- Stamford, Conn., 674-676 Main St. (at Grove St.)
- White Plains, N. Y., 80 Main St. (off Lexington Ave.)
- Newark, N. J., 29-31 Central Ave. (at Halsey St.)
- Englewood, N. J., 3-5-7 Grand Ave. (off Palisade Ave.)
- Greenbrook, N. J., (Route 29)
- Hempstead, L. I., 74 North Franklin St., (near Fulton Ave.)
- Farmingdale, L. I., (Route 110)

Salterini NEVA-RUST*

*REG. U. S. PAT. OFF.

WROUGHT IRON FURNITURE

GUARANTEED AGAINST RUST FOR 6 YEARS

*Beauty
that Lasts*

**ILLUSTRATED
ON FRONT COVER**

Here's outdoor living at its best. Fine quality Salterini NEVA-RUST furniture invites you and your guests to take things easy this summer. Long famous for quality and distinctive styling, your elegant Salterini furniture will win compliments for years . . . for here truly is beauty that lasts. The patented NEVA-RUST process protects all Salterini furniture against the ravages of rust. It is unqualifiedly guaranteed for a minimum period of six years against rust corrosion. The following finishes are standard: White, Aquamist (turquoise-blue flecked with white,) Flamingo (a warm vibrant coral relieved with dusty sand tones), Statuary Bronze (antique brown flecked with green). Prices include covering knife and box edge cushions in sail-cloth which has been vat dyed and is water repellent; slip seats covered in plastic-coated fabrics. All tables under 5 feet square have $\frac{3}{16}$ -in. glass tops. Tables larger than 5 feet square have $\frac{3}{8}$ -in. glass tops. All edges are ground for safeguarding.

659 Double Chaise Longue. Length 65 in. Width inside 44 in., outside 52½ in. Adjustable back with 2½-in. Box Cart-ridge Cushion. \$245.00.

608 Lounge Chair. Width inside 23 in., outside 34 in. Diam. inside 21 in. Height 43 in. Back: Reversible 2-in. Box Cushion with muslin inner lining. Seat: Reversible 5-in. Box Spring Cushion. \$130.00.

541 End Table. Top: Length 28 in. Width 18 in. Height 24 in. \$50.00.

607 Sofa. Length inside 65½ in., outside 76½ in. Diam. inside 21 in. Height 42½ Back: Reservible Box Cushions with muslin inner lining. Seat: Reversible 5-in. Box Spring Cushions. \$300.00.

539 Cocktail Table. Top: Length 36 in. Width 36 in. Height 18 in. \$82.50.

725A Arm Chair. Width inside 20 in., outside 27½-in. Diam. 17 in. Height 37 in. Reversible 1½-in. Box Cushion. \$52.50.

538 Nest of Tables. Large Table: 16 x 16 in. Center Table: 14 x 14 in. Small Table: 12 x 12 in. Height overall 20 in. \$33.00.

Many other dining and living groups for indoor and outdoor use priced from \$100.00.

Keep Your Lawn Well Groomed The Effortless Way

SAWCO SPECIAL



- No gas and oil mixing with 4-cycle engine.
- Cuts smooth clean mat full 20 inches wide.
- Automatic governor for even precision cutting.

\$139.50

Give your lawn that well-groomed look with the SAWCO SPECIAL precision cutting power mower. Four exclusive features make it the mower that owners recommend: (1) Special high precision ball bearings—no need ever to lubricate. (2) Three special lugs prevent tire from slipping on the wheel. (3) Positive wheel drive means chalk-line mowing. (4) Drop-out reel makes servicing simple. Adjustable handle makes mowing easy for the whole family. Cutter blade sharpens itself while you mow. You get extra power for climbing knolls and terraces from the 4-cycle 1 to 1½-h.p. gasoline engine.

IDEAL "VICTOR 24"

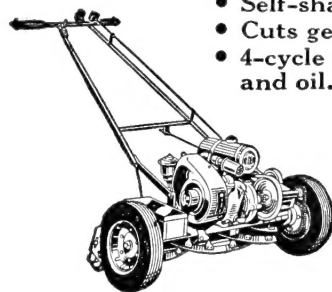

- Designed for smooth handling.
- Self-sharpening cutting reel.
- Cuts generous 24-in. swath.
- 4-cycle engine . . . no need to mix gas and oil.

\$249.50

Newly designed, popular-priced quality power with 24-in. cutting width. Takes the work out of lawn tending for large homes, parks, playgrounds and public buildings. Smooth-running, precision ball bearings on the 24-in. cutters shorten time and trips around broad lawn areas. Independent controls for speed, traction and cutting reel are handy, right up on the sturdy steel handlebars. Tool box mounted on frame. Four-cycle engine.

Also 28-in. cut for larger areas. \$284.50.

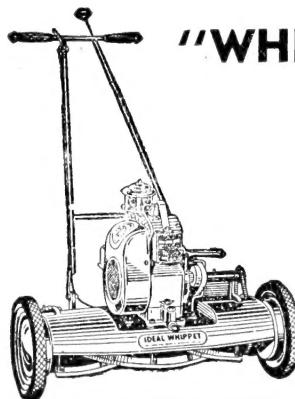

"WHIPPET 21" • \$159.95

Sturdy, durable mower for easy lawn tending and the cost is well within the average home-owner's budget. Designed for modest homes, The Whippet 21 is ideal quality throughout. Easy handling and convenient to use. 21-in. cutting reel with 6-in. diam. Its narrow all-over width lets it mow close to trees, shrubs, and flower beds. 4-cycle gasoline engine . . . no fussing with gas and oil mixing. Handle raises for easy storing.

Stumpp & Walter's Delphinium

Where the Blues Begin ▲▲

DELICATE TINTS AND EXOTIC HUES IN THIS CYCLE OF BLUES

Mostly exceeding 6 feet, these striking perennials produce magnificent flower-spikes in July and August; cut them down after blooming for a second growth in fall. Many treat as an annual, sowing under glass in midwinter.

Giant Pacific Hybrids

These New Hybrids are so much larger and finer than the best varieties produced hitherto, that they have deeply impressed all who have seen them. All the florets are 2 inches or more across, and they are excellent for show purposes.

Black Knight Series. Very dark blues.

Cameliard Series. Lavender selfs.

Galahad Series. White.

Above 3, each, pkt. \$1.50, 1/8oz. \$4.25, 1/4oz. \$8

Blue Bird Series. Clear mid-blue with white bee.

***Blue Jay.** Blue, gray overtone; dark bee.

***Guinevere Series.** Pink-lavender; white bee.

***King Arthur.** Royal violet; white bee.

***Summer Skies.** Light blue; white bee.

Above 5, each, pkt. \$1, 1/8oz. \$4, 1/4oz. \$7.50

COLLECTION: Pkt., each, varieties marked * \$3.50

Round Table Series. Noble mixture. Pkt. \$1, 3 pkts. \$2.50, 1/8oz. \$3.25, 1/4oz. \$6.

Mixture, all Shades

Pkt. 50 cts., 3 pkts. \$1.25, 1/8oz. \$2.50, 1/4oz. \$4.

Some Other Fine Varieties

New Hollyhock Strain. A fine mixture of all light shades, pale clear blue predominating. Large flowers, truly double, 6 ft. Pkt. 35 cts., 3 pkts. \$1, 1/8oz. \$1.50, 1/4oz. \$2.50.

Belladonna. Clear turquoise-blue flowers. Everblooming. 5 ft. Pkt. 15 cts., 1/8oz. 60 cts., 1/4oz. \$1.

Cliveden Beauty (Improved Belladonna). Bright blue. Larger flowers and a stronger plant are the advantages of this strain. 5 ft. Pkt. 25 cts., 1/8oz. 85 cts., 1/4oz. \$1.50.

Bellamosum. Blue; 5 ft. Similar to the above except in color which is a darker blue. Pkt. 15 cts., 1/8oz. 60 cts., 1/4oz. \$1.

Cardinale. Beautiful cardinal-red. 2 1/2 ft. Pkt. 25 cts., 1/8oz. 85 cts., 1/4oz. \$1.50.

Chinense, Blue Butterfly. Fine feathery foliage, and many spikes of large blossoms of intense gentian-blue. 1 1/2 ft. Pkt. 15 cts., 1/4oz. 50 cts., oz. \$1.50.

Chinense, Cambridge Blue. Clear, rich light blue. Fine for cut-bloom. 2 1/2 ft. Pkt. 20 cts., 1/8oz. 60 cts., 1/4oz. \$1.

Chinense album. White form. 3 ft. Pkt. 15 cts., 1/4oz. 50 cts., oz. \$1.50.

GOLD MEDAL HYBRIDS, Mixed. Immense spikes, and the best colors. Recommended to the specialist. Pkt. 35 cts., 1/8oz. \$1, 1/4oz. \$1.75, oz. \$6.

GIANT-FLOWERED PANSIES (Treat as Annuals or Biennials)

Sow in April and again in July and August in a light, cool, but well-moistened soil, enriched with General Garden Fertilizer. Cover them three times their diameter, and firm the soil. Seed-bed should not

be allowed to dry out. Transplant to 1 foot apart. Protected in winter under glass, summer-sown plants are put out in bloom in April; carried over in the open they flower a month later.

SUPER-PASTORAL GIANTS. This superb strain of giant fancy Pansies is the culmination of years of scientific culture. A vigorous root-system enables it to bloom well into hotweather. Flowers are round, of immense size, firm texture with strong stems.

Emperor William Blue

Light Lavender

Pure Golden Yellow

Snow-White

Super-Pastoral Giants, Mixed

Each, pkt. \$1, 1/16oz. \$3.50, 1/8oz. \$6, 1/4oz. \$10, oz. \$35

Pastoral Giants

The Pastoral Giants embrace a wider range of color than other large Pansies. Many are frilled and sweetly perfumed.

Pure Golden Yellow.

Pure Snow-white.

Lavender (light).

Emperor William Blue (dark).

Fancy Red Shades.

Bronze Shades.

Yellow, Dark Eye.

Pastoral Giants Mixed.

Each, pkt. 50 cts., 1/16oz. \$2, 1/8oz. \$3.50, 1/4oz. \$6, oz. \$20

CORONATION GOLD. Flowers 3 inches across, with ruffled edges. Color is canary-yellow, lower petals flushed orange. Pkt. 50 cts., 3 pkts. \$1.25, 1/8oz. \$3.50.

SAWCO EXHIBITION STRAIN. Includes the finest varieties, with blooms of good size, splendid texture, and plants of robust constitution, holding their flowers well above the foliage. Every color combination is included. Pkt. 50 cts., 1/8oz. \$2.50, 1/4oz. \$4, oz. \$15.

SWISS GIANT, MIXED. Large blooms and their shape is good; among them are many unusual shades. They stand warm weather well. Pkt. 35 cts., 3 pkts. \$1, 1/8oz. \$2, 1/4oz. \$3.50, oz. \$12.

NON PLUS ULTRA, MIXED. For the gardener who desires his beds of good quality and with every color. Pkt. 25 cts., 5 pkts. \$1, 1/8oz. \$2, 1/4oz. \$3, oz. \$10.

MIXED BEDDING PANSIES. All colors. Pkt. 15 cts., 1/8oz. \$1, 1/4oz. \$1.50, oz. \$5.

BABY DELIGHT. Beautiful waved blooms are light blue. They appear in ten weeks from seed. Pkt. 25 cts., 5 pkts. \$1, 1/8oz. \$1.50, 1/4oz. \$2.50.

Giant Greenhouse Pansies

SAWCO STUPENDOUS. Remarkable strain of gigantic proportions for indoor culture, offered exclusively by us. The plants grow 4 feet high. Carried on thick, stiff stems, 18 inches long, are enormous flowers 4 to 4 1/2 inches across and in a complete color-range. For the professional gardener and producing florist. May be grown in the open, also, but with winter protection. Pkt. \$2, 3 pkts. \$5.

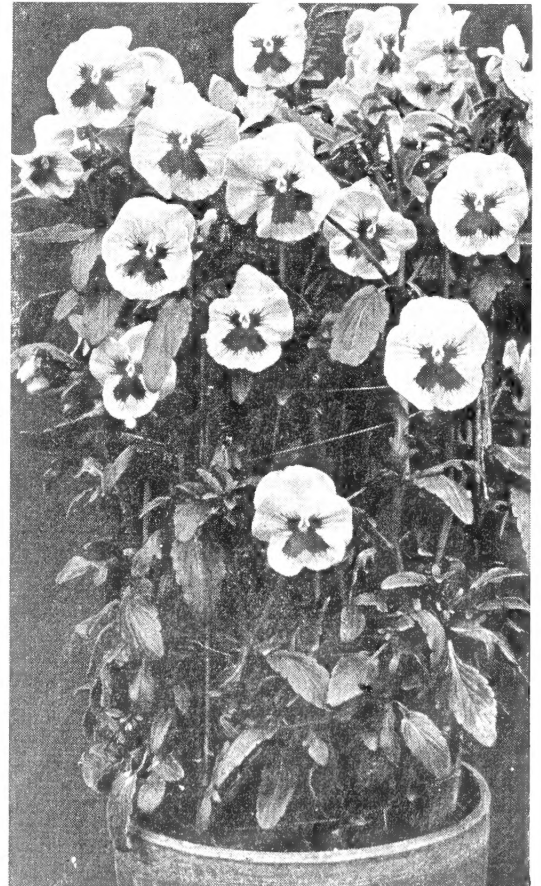

Photograph of a plant grown in a pot showing vigor and free-flowering habit of this strain. Seed sown July 20. First flower appeared November 25. Up to May 15 plant has produced 305 blooms. →→→

PERENNIAL FLOWER SEED FOR SUMMER AND EARLY FALL SOWING, continued

| | Color | Height Inches | Time of Flowering | Per Pkt. | | Color | Height Inches | Time of Flowering | Per Pkt. |
|-------------------------------------|----------------|------------------|----------------------|-------------|-------------------------------------|----------------|------------------|----------------------|-------------|
| Hollyhock, Double | | | | | Salvia | | | | |
| Orange Prince..... | Apricot-orange | 72 | Summer | \$0.25 | Farinacea..... | Light blue | 30 | July-Oct. | \$0.25 |
| Exquisite..... | Various | 72 | Summer | .25 | Farinacea, Blue Bedder.. | Deep blue | 36 | July-Oct. | .35 |
| Haile Selassie..... | Maroon | 72 | Summer | .35 | Saponaria | | | | |
| Chater's Superb Double | | | | | Ocymoides..... | Pink | 9 | July-Sept. | .25 |
| Deep Rose; Pure White; | | | | | Scabiosa | | | | |
| Newport Pink; Sal- | | | | | Giant Hybrids (Isaac | | | | |
| mon-Rose; Scarlet; | | | | | House Strain)..... | Various | 36 | Summer | .35 |
| Sulphur-Yellow; Mixed | | 72 | Summer | .25 | Caucasica (Blue Bonnet).. | Lilac-blue | 36 | Summer | .25 |
| S. & W. Single Mixed. Various | | 72 | Summer | .15 | Caucasica Alba..... | White | 36 | Summer | .25 |
| Honesty (Moonwort). Biennial | Purple | 24 | Aug., Sept. | .15 | Sidalcea (Checkerbloom) | | | | |
| Lathyrus Latifolius (Hardy | | | | | Stark's Hybrids..... | Various | 36 | July, Aug. | .15 |
| Sweet Peas) | | | | | Silene (Autumn Catchfly) | | | | |
| White; Pink Beauty; Red; | | | | | Schafta..... | Pink | 6 | July-Sept. | .25 |
| Mixed..... | | 72-96 | Summer | .20 | Stokesia (Cornflower Aster) | | | | |
| Liatriis (Blazing Star) | | | | | Cyanea..... | Lavender-blue | 24 | July to Frost | .25 |
| Pycnostachya..... | Rosy purple | 42 | July-Sept. | .25 | Strawberries, Alpine | | | | |
| Linaria (Kenilworth Ivy) | | | | | Baron Solemacher..... | | 9 | | .35 |
| Cymbalaria..... | Lavender and | 6 | Summer | .15 | Sweet William (Biennial) | | | | |
| Linum (Flax) | | | | | Tall Varieties | | | | |
| Perenne..... | Bright blue | 18 | June to Fall | .15 | Single White..... | White | 18 | May, Aug. | .25 |
| Flavum (Golden Flax)..... | Yellow | 6 | June to Fall | .50 | Single Dark Crimson..... | Dark crimson | 18 | May, Aug. | .25 |
| Lupinus Polyphyllus | | | | | Single Tall, Mixed..... | Various | 18 | May, Aug. | .15 |
| Russell (Reselected Strain) | Various | 36-48 | May, June | .25 | Double Tall, Mixed..... | Various | 18 | May, Aug. | .20 |
| Pink Shades; Golden Spire; | | | | | Newport Pink..... | Watermelon- | 18 | May, Aug. | .25 |
| Red Shades; Pure White | | | | | | pink | 18 | May, Aug. | .25 |
| Blue Shades; Mixed..... | | 36-48 | May, June | .25 | Scarlet Beauty..... | Deep scarlet | 18 | May, Aug. | .25 |
| Lychnis (Catchfly) | | | | | Holborn Glory..... | Various, white | 18 | May, Aug. | .25 |
| Viscaria Splendens..... | Rose-pink | 18 | June, July | .15 | | eye | | | |
| Haageana..... | Orange-scarlet | 18 | July | .25 | Dwarf Varieties | | | | |
| Chalcedonica..... | Scarlet | 24 | June, July | .15 | Single Dwarf, Mixed..... | Various | 6 | May, Aug. | .15 |
| Myosotis (Forget-Me-Not) | | | | | Double Dwarf, Mixed..... | Various | 6 | May, Aug. | .15 |
| Alpestris, Royal Blue..... | Indigo-blue | 12 | May | .25 | Valerian (Garden Heliotrope) | | | | |
| Alpestris Victoria, Blue..... | Indigo-blue | 8 | May | .25 | Red..... | Deep red | 48 | June, July | .15 |
| Alpestris Oblongata, Blue | | | | | Veronica (Speedwell) | | | | |
| Bird..... | Deep blue | 15 | May | .25 | Spicata, Blue..... | Bright blue | 24 | July-Sept. | .25 |
| Palustris Semperflorens | | | | | Spicata, Mixed..... | Various | 24 | July-Sept. | .20 |
| (Everblooming Forget- | | | | | Viola (Tufted Pansies) | | | | |
| Me-Not)..... | Clear blue | 6 | May-Sept. | .25 | Cornuta Types | | | | |
| Ruth Fisher..... | Deep blue | 12 | May | .50 | Blue Gem (Jersey Gem) | Violet-blue | 6 | May-Sept. | .50 |
| Pansy. See page 3. | | | | | Lutea Splendens..... | Yellow | 6 | May-Sept. | .50 |
| Pentstemon (Beard Tongue). | | | | | White Perfection..... | White | 6 | May-Sept. | .50 |
| Sensation..... | Various | 24 | July-Sept. | .25 | Large-flowering Types | | | | |
| Phlox, Hardy | | | | | Arkwright Ruby..... | Terra-cotta | 6 | May-Sept. | .50 |
| Large-flowering Tall Hy- | | | | | Blue Butterfly..... | Mid-blue | 6 | May-Sept. | .50 |
| brids..... | Various | 36 | Summer | .15 | | shaded white | 6 | May-Sept. | .50 |
| Pinks. See Dianthus. | | | | | Blue Perfection..... | Medium clear | 6 | May-Sept. | .50 |
| Platycodon (Balloon Flower) | | | | | | blue | 6 | May-Sept. | .50 |
| Grandiflorum, Blue..... | Steel blue | 12 | May | .25 | Chantryland..... | Apricot | 6 | May-Sept. | .50 |
| Grandiflorum Mariesii..... | Various | 12 | Summer | .25 | Papilio..... | Blue and white | 6 | May-Sept. | .35 |
| Polemonium (Jacob's Ladder) | | | | | Finest Mixed..... | Various | 6 | May-Sept. | .35 |
| Coeruleum Grandiflorum | Deep blue | 24 | Summer | .10 | Wallflower | | | | |
| Polyanthus (Primula elatior) | | | | | Single Mixed..... | Various | 24 | May-June | .15 |
| Giant Mixed..... | Various | 6 | Spring | .35 | Double Mixed..... | Various | 24 | May-June | .25 |
| Blue Beauty..... | Blue | 6 | Spring | .50 | | | | | |
| Poppy | | | | | | | | | |
| Oriente, Scarlet..... | Scarlet | 24 | June-Aug. | .35 | | | | | |
| Oriente, Oriflamme..... | Orange-scarlet | 24 | June-Aug. | .35 | | | | | |
| Oriente, Princess Vic- | | | | | | | | | |
| toria..... | Salmon | 24 | June-Aug. | .35 | | | | | |
| Oriente, Mixed..... | Various | 24 | June-Aug. | .20 | | | | | |
| Iceland, The Emperor..... | Tangerine | 18 | June-Aug. | .35 | | | | | |
| Iceland, The Empress..... | Salmon-rose | 18 | June-Aug. | .35 | | | | | |
| | and pink | | | | | | | | |
| Iceland, Yellow Wonder..... | Buttercup- | 36 | June-Aug. | .35 | | | | | |
| | yellow | | | | | | | | |
| Iceland, Coonara Pink..... | Rose-pink and | 12 | June-Aug. | .25 | | | | | |
| | salmon | | | | | | | | |
| Iceland, Sanford's Giant | | | | | | | | | |
| Strain, Mixed..... | Various | 18 | June-Aug. | .25 | | | | | |
| Iceland, Single Mixed..... | Various | 12 | June-Aug. | .15 | | | | | |
| Tibetan (Meconopsis Bail- | | | | | | | | | |
| eyi)..... | Sky-blue | 48 | June-Aug. | .50 | | | | | |
| Primula | | | | | | | | | |
| Japonica Hybrids, Mixed..... | Various | 24 | April | .35 | | | | | |
| Veris, Mixed (Cowslip)..... | Various | 12 | April | .35 | | | | | |
| Vulgaris (True English | | | | | | | | | |
| Primrose)..... | Canary-yellow | 6 | April | .35 | | | | | |
| Pyrethrum (Painted Daisy) | | | | | | | | | |
| Double Hybrids, Mixed..... | Various | 36 | June | .35 | | | | | |
| Single Hybrids, Mixed..... | Various | 36 | June | .25 | | | | | |
| Ranunculus Asiaticus | | | | | | | | | |
| Tecolote Hybrids..... | Various | 12 | May | .75 | | | | | |

Special Offers of Perennial Flower Seeds in Collections

COLLECTION No. 59 G \$1.75

12 Packets, Most Popular Perennials

- | | |
|--------------------------------------|-----------------------------------|
| Alyssum saxatile | Dianthus, Double Plumarius, Mixed |
| Aquilegia, Long-spurred, Mixed | Digitalis, Giant Shirley, Mixed |
| Arabis alpina | Forget-me-not, Royal Blue |
| Chrysanthemum, Alaska (Shasta Daisy) | Gaillardia, Giant Hybrids |
| Coreopsis grandiflora, Sunburst | Poppy, Oriental, Scarlet |
| Delphinium, Gold Medal Hybrids | Pyrethrum Hybrids, Single |

COLLECTION No. 59 H \$1.75

12 Packets, Perennials for Rock-Gardens

- | | |
|----------------------------------|-------------------------------|
| Alyssum saxatile | Dianthus Allwoodi, Mixed |
| Arabis alpina | Geum, Lady Stratheden |
| Armeria, Large-flowering Hybrids | Linum perenne, Blue |
| Campanula carpatica | Polyanthus, Giant, Mixed |
| Candytuft (Iberis gibraltarrica) | Poppy, Iceland, Single, Mixed |
| Cheiranthus Allioni | Saponaria ocymoides |

COLLECTION No. 59 K \$2.00

12 Packets, Perennials for Cut-Bloom

- | | |
|---------------------------------|--------------------------------|
| Aquilegia, Long-spurred, Mixed | Delphinium, Gold Medal Hybrids |
| Aster alpinus, Mixed | Gaillardia, Giant Hybrids |
| Campanula pyramidalis, Blue | Gypsophila paniculata |
| Centaurea montana, Blue | Myosotis, Blue Bird |
| Chrysanthemum, Alaska | Pyrethrum, Single Hybrids |
| Coreopsis grandiflora, Sunburst | Scabiosa caucasica |

Flower Seeds for the Greenhouse

GREENHOUSE ANTIRRHINUMS

To obtain a succession of bloom, monthly sowings are usually made, starting in July.

Afterglow. Bronze. Pkt. \$1.
America. Brilliant rose-pink with orange lip, blending into pure lemon. Fine winter bloomer. Pkt. \$2.
Bertha Baur. Lavender. Pkt. \$1.
Better Times. Real American Beauty rose color. Pkt. \$2.



Antirrhinum

CALCEOLARIA

(Slipperwort)

Greenhouse or Bedding Plant
Pouch-like flowers

Giant Strain. English. Enormous blooms; finest obtainable. Mixed colors.

Multiflora Nana Type

Cloth of Gold. Large trusses of immense blooms; pure deep yellow.

Indian Prince. Bright orange-scarlet.

Mixed. Ideal for bedding; small flowers in great profusion. All combinations of yellows, orange and brown.

Above, each, pkt. 50 cts., 3 pkts. \$1.25

CINERARIA

Greenhouse Annual

Brilliant colors in daisy-shape blooms. Sow May-September. Transfer direct from seed-pans to thumb-pots; place in coldframe. As pots become full of roots, shift to larger ones until flowering size is reached.

Siter's Rainbow Strain. Small foliage and immense flower-heads; individual blooms are medium large, and most have a white eye. Pkt. \$2, 3 pkts. \$5.50.

Cremer's Prize Strain. Flowers large and color-range exceptionally fine. Florets are wide, and they overlap well. Smaller leaves than those of the old type. Resistant to wilt. Pkt. \$1.50, 3 pkts. \$4.

Bezdek's Yellow Wonder. One of the best yellows. Pkt. \$2.

Ceylon Court. Yellow. Pkt. 50 cts.

Cheviot Maid Supreme. Dark rose-pink. Pkt. 75 cts.

Cheviot Maid, Yellow. Long-stemmed; pure medium yellow. Pkt. \$1.

Christmas Cheer. Fine rose; midwinter. Heavy yielder. Pkt. \$1.50.

Ethel. Finest early golden yellow. Pkt. \$1.50.

Glorious. Scarlet-bronze. Early. Pkt. \$2.

Hodaly's Ideal. Sensational prize-winner. Carmine, shading to orange and lavender, tipped yellow; white throat. Pkt. \$2.

Junglewood White. New York Florists' Club Silver Medal. Pure white; deep green foliage; long stems. Pkt. \$2.

Junglewood Yellow. A rich yellow by the introducer of Junglewood White. Strong grower. Pkt. \$2.

Klondyke Supreme. Very deep yellow. Early. Pkt. \$1.50.

Koster's White. One of the best and most popular pure white Snaps. Vigorous grower; long, strong stems. Pkt. \$2.

Lady Dorothy. New York Florists' Club Silver Medal. Beautiful reddish bronze. Early. Pkt. \$3.

Lucky Strike. White. Pkt. \$1.

Marie Louise. Splendid shell-pink. Pkt. \$2.

Maryland Pink. Light pastel pink. Pkt. \$3.

Radiance. Large; deep rose-pink. Pkt. \$1.

Schafforth's Early Pink. Bright color. Pkt. \$2.

St. Louis Early Pink. One of the best. Pkt. \$2.

Talisman. Florets are semi-double and double, and their color is a combination of rose and golden bronze. Early. Pkt. \$2.

Terry's Surprise Improved. Rose, shaded bronze. Pkt. \$1.50.

Velvet Beauty. Fine rose-red. Pkt. \$1.

Westover's Fringed White. Reliable sort; beautiful white, cream tip. Pkt. \$1.

White Rock. Pkt. 50 cts.

White Wonder. The finest pure white, with large, close spikes. 5 ft. Pkt. \$1.50.

California Super-Giants, Mixed. Prize Cinerarias, grown by a specialist. Numerous individual flowers, exceeding 5 inches in diameter, with florets 1 to 1½ inches wide. Pkt. 75 cts., 3 pkts. \$2.

Multiflora nana, Potsdam, Mixed. Extra-choice, dwarf strain. Plants completely covered with brightly colored flowers. Pkt. 50 cts., 3 pkts. \$1.25.

LARKSPUR

Giant Imperial Sorts

Plants of giant proportions with the habit of the delphinium. Height up to 5 ft.

***Blue Spire.** Double Oxford-blue flowers.

***Dazzler.** Vivid, lustrous carmine. Blooms ten days earlier than most.

***Exquisite Pink Improved.** The shade of pink meets exactly the florists' needs.

Gloria Improved. A rich tone of deep rose, with no trace of carmine.

Lilac King. Clear lilac—rich shade that is welcomed by every gardener. 4 ft.

Pink King. Soft, salmon-rose. 5½ ft.

***Sweet Lavender.** Good rich lavender-blue.

***White King.** The finest white variety.

Mixed Giant Imperial Larkspurs.

Each, pkt. 15 cts., ¼oz. 60 cts., oz. \$2
COLLECTION: 5 varieties marked *, 60 cts.

STOCKS

S. & W.'s Non-Branching

We are pleased to be able to offer this wonderful strain producing true one-stalk plants. The flower-spikes produce from 15 to 20 improved double blooms.

WHITE VARIETIES

Pure White. Our best pure white. Large florets and well-formed, compact spikes.

Gardenia. An outstanding white. Late.

PINK, RED AND ROSE VARIETIES

Ball Supreme. Rich silvery rose; extra-long, heavy spikes.

Deep Rose. Bright rose-pink.

Chamois-Rose. Blending of creamy buff and pink.

Ruby. Crimson-red; fine long stems.

American Beauty. Similar to the American Beauty rose.

BLUE, LAVENDER AND PURPLE VARIETIES

Lilac-Lavender. The most popular variety in this shade.

Silvery Lilac. A very attractive shade.

Purple. Deep purple with long stems.

Ball Blue. Rich lilac shade.

MISCELLANEOUS VARIETIES

Yellow Wonder. Deep creamy yellow.

Mixed. A special mixture consisting of all the popular colors.

Each of the above, pkt. 75 cts., ¼oz. \$2,
 ¼oz. \$3.75

EARLY GIANT IMPERIAL STOCKS

These bloom very quickly. Plants are of branching habit, 2 to 2½ feet high.

***Antique Copper.** Rich hellebore-red, overlaid with copper. Fully double.

***Buttercup.** An improved new yellow Stock of a rich deep tone.

***Elk's Pride.** An intense royal purple; sweetly perfumed, double flowers.

***Shasta.** A new, glistening, giant white; longer stems and more blooms to the stem.

***Chamois-Rose** **Blood-Red**

Apple Blossom **Deep Rose**

Dark Blue **Mixed** ***Lavender**

Each, pkt. 25 cts., ¼oz. \$1, ¼oz. \$1.75

COLLECTION:

Pkt. each of 6 varieties marked *, \$1.25

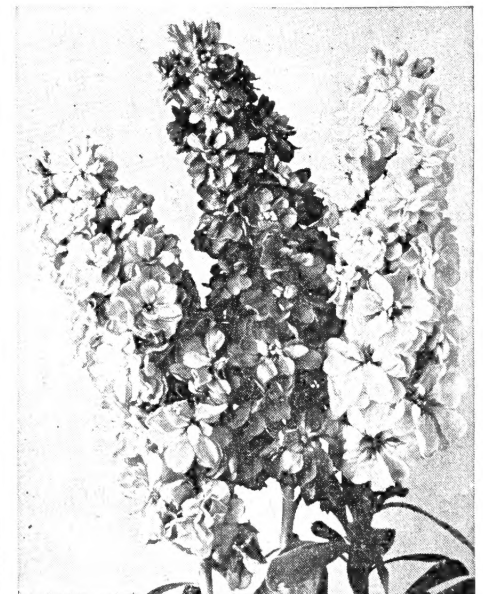

Stocks, S. & W.'s Non-Branching

Keep Your Garden Producing All Summer!

FOR FOOD, HEALTH AND GOOD LIVING

A continuous program of vegetable gardening will be of great benefit. In addition to the contribution, gardens make to better nutrition, their value in providing outdoor physical exercise, recreation and relaxation from the strain of modern life is widely recognized.

BUSH BEANS

Sow every two weeks to August 1

Keystoneian. (Green-pod Bush.) An All-America winner. The best all-purpose Bean. Pods are long, straight, stringless, fiberless, dark green and delicious. Pkt. 20 cts., ½lb. 35 cts., lb. 65 cts., 5 lbs. \$3.

Longreen. *New.* Winner for 1946 of the All-America Seed Trials. Pods are 1 inch longer than other modern sorts, round, meaty, with no fiber or strings; their flavor is the best. The large plant seems hardier and a more certain cropper. Pkt. 20 cts., ½lb. 35 cts., lb. 65 cts., 5 lbs. \$3.

Bountiful. Very prolific, tender, delicious flat pods. Pkt. 15 cts., ½lb. 35 cts., lb. 60 cts., 5 lbs. \$2.75.

Stringless Refugee. A heavy cropper. Good for pickling or canning. ½lb. 30 cts., lb. 60 cts., 5 lbs. \$2.75.

Streamliner. A long, stringless, green, flat-podded Bean. Pkt. 15 cts., ½lb. 35 cts., lb. 65 cts., 5 lbs. \$3.

Sure-Crop Stringless (Wax). Resistant to rust. Bears an abundance of flat, stringless wax Beans. Pkt. 15 cts., ½lb. 35 cts., lb. 60 cts., 5 lbs. \$2.75.

LIMA BEANS

Sow to July 1

Fordhook 242. (Bush.) An improved Fordhook and an All-America winner. Pkt. 20 cts., ½lb. 40 cts., lb. 75 cts., 5 lbs. \$3.50.

BEET

Follow your early-maturing row of vegetables with a row of Beets. Sow to August 1.

Improved Wonder. Has all the fine qualities of Early Wonder, but in addition, has a fine, dark-colored flesh. Tender and sweet. Pkt. 20 cts., oz. 45 cts., ¼lb. \$1.25.

Detroit Dark Red. Round, dark red, globe shape. A good winter keeper. Pkt. 15 cts., oz. 35 cts., ¼lb. \$1.

Winter Keeper. A distinct and very fine strain for main crop. Produces large Beets of fine quality and very sweet flavor. Pkt. 20 cts., oz. 45 cts., ¼lb. \$1.25.

BROCCOLI

Sow in July for late crops

Italian Market. Produces compact, bluish green heads of very fine flavor. Pkt. 25 cts., ¼oz. 55 cts., ½oz. 90 cts.

BRUSSELS SPROUTS

Sow in June-July

Favorite. A half-dwarf strain, giving tight sprouts, tender and delicious. Pkt. 25 cts., ¼oz. 55 cts., ½oz. 90 cts.

CHINESE CABBAGE

Sow July 15 to August 15

An easy and desirable vegetable to grow. **Pe-Tsai.** Looks like a long Cos lettuce. Pkt. 15 cts., ½oz. 40 cts., oz. 75 cts.

CARROTS

Sow to July 15

Tendersweet. A long Carrot, deep in color, tender and sweet. Pkt. 15 cts., oz. 55 cts., ¼lb. \$1.50.

Rubicore. A half-long, stump-rooted Carrot. Fine-flavored, popular variety. Pkt. 15 cts., oz. 55 cts., ¼lb. \$1.50.

Melting Marrow. A fine, half-long variety, cylindrical in shape and of wonderful quality. Coreless; short tops. Pkt. 20 cts., oz. 60 cts., ¼lb. \$1.75.

CORN Sow to July 15

Golden Bantam. A favorite with everyone. Pkt. 15 cts., ½lb. 30 cts., lb. 50 cts., 5 lbs. \$2.25.

Honey Cross. A first-early hybrid. A good variety for the small garden as well as the market. Disease resistant. Kernels light cream-yellow, very sweet. Pkt. 20 cts., ½lb. 50 cts., lb. 90 cts.

Golden Midget. An exceptional Corn. The plant grows about 30 inches high. Ears 4 inches long and quality the very highest. Size permits growing in small areas and closer together. Large pkt. 75 cts., ½lb. \$1.50.

CORN SALAD, Large-leaved. One ounce will plant 150 feet of drill. Sow in early spring and early fall. The latest sowings may be wintered if lightly mulched. Pkt. 15 cts., oz. 40 cts., ¼lb. \$1.25.

CUCUMBER Sow to early July

Staysgreen. Reliable and popular commercial white spine. Suitable for slicing or pickles. Pkt. 15 cts., oz. 40 cts., ¼lb. \$1.10.

ENDIVE Sow to August 1

Full Hearted. Makes a good compact head that blanches easily. Pkt. 15 cts., oz. 40 cts., ¼lb. \$1.

Green Curled Rose-Ribbed. Deeply cut leaf margins. Quick to mature. Pkt. 15 cts., oz. 40 cts., ¼lb. \$1.

LETTUCE Sow to August 1

Unrivalled Summer. A good heading type, quick to grow. Pkt. 15 cts., oz. 45 cts., ¼lb. \$1.15.

Imperial No. 456. An "Iceberg" type; splendid for late sowing. Large heads. Pkt. 25 cts., oz. 85 cts., ¼lb. \$2.50.

Trianon Cos. An extra good Romaine type. Pkt. 15 cts., oz. 45 cts., ¼lb. \$1.15.

Oakleaf or Summer Triumph. Semi-heading; stands heat. Has a buttery and sweet flavor. Pkt. 20 cts., oz. 60 cts., ¼lb. \$1.75.

KALE Sow to August 1

Makes delicious winter greens.

Dwarf Curled Scotch. Hardy and yields heavily; withstands frost. Curled leaves. Pkt. 15 cts., oz. 45 cts., ¼lb. \$1.25.

KOHLRABI Sow to August 1

Earliest Selected. Very refined flavor; quick to mature. Pkt. 20 cts., ½oz. 75 cts., oz. \$1.40.

PEAS Sow July 15 to August 15

First of All or Pedigree Extra-Early. Peas tender, well flavored, in long, tightly filled pods. 60 days from planting to picking. Height 30 inches. Pkt. 10 cts., ½lb. 30 cts., lb. 50 cts., 5 lbs. \$2.25.

Little Marvel. Eighteen inches high, heavily set with fine pods, usually in pairs. Pods are 3½ inches in length, square, filled with large, deep green Peas. 62 days. Pkt. 10 cts., ½lb. 30 cts., lb. 50 cts., 5 lbs. \$2.25.

RADISH

Sow July 15 to August 15

Early Scarlet Globe. The popular, round-oval, scarlet Radish. Short tops; quick to mature. Pkt. 10 cts., oz. 35 cts., ¼lb. 75 cts.

Long Black Spanish. The popular winter sort. Pkt. 15 cts., oz. 40 cts., ¼lb. \$1, lb. \$2.

Round Black Spanish. Suitable for winter storage. Pkt. 15 cts., oz. 40 cts., ¼lb. \$1, lb. \$2.

Sparkler. Rich carmine-scarlet with white tip. Leaves small. Quick grower. Pkt. 10 cts., oz. 35 cts., ¼lb. 75 cts.

RUTABAGA (Yellow Turnip)

Sow to July 15

Long Island Improved. Large, neckless type, of fine quality. Good for winter use. Pkt. 10 cts., oz. 35 cts., ¼lb. 85 cts.

SPINACH

Sow August 1 to September 1

Blight-Resistant Savoy. Good variety for late sowings; savoy leaved. Pkt. 10 cts., oz. 30 cts., ¼lb. 75 cts.

Emerald Standing. Large and vigorous type. Slow to bolt to seed. Pkt. 15 cts., oz. 40 cts., ¼lb. \$1.00.

New Zealand. (Sow in May.) Furnishes a summer supply of greens. Withstands drought and hot weather. Pkt. 15 cts., oz. 50 cts., ¼lb. \$1.25.

SQUASH Sow in May

Zucchini. Prolific; tender, mild flavor. Pkt. 15 cts., oz. 50 cts., ¼lb. \$1.25.

Butternut. Club-shaped fruits, thick at blossom end; contains but few seeds. Pkt. 15 cts., oz. 70 cts.

SWISS CHARD

Sow to August 1

Gives a continuous supply of foliage, making a suitable substitute for spinach.

Fordhook. A large variety with broad, wrinkled, dark green leaves and broad white rib. Pkt. 15 cts., oz. 40 cts., ¼lb. \$1.

TURNIP

Sow July 25 to August 25

Purple-Top White Globe. Good for storing over winter. Pkt. 10 cts., oz. 30 cts., ¼lb. 65 cts.

Early White Milan. Quick to mature. Flat bulb. Pkt. 15 cts., oz. 35 cts., ¼lb. 85 cts.

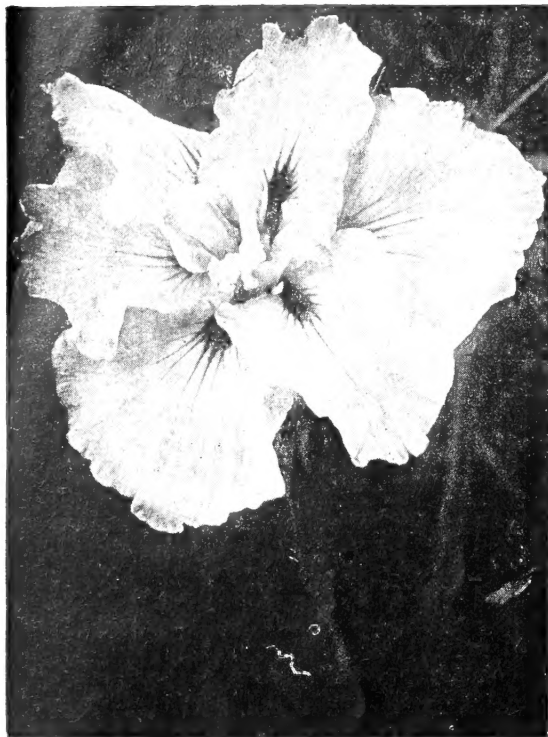

Iris Kaempferi

IRIS KAEMPFERI • *Oriental Iris*

These flower after the Bearded Irises have gone, and will do well in almost any location, but especially well where it is moist.

IMPROVED VARIETIES.

Elbrus. Double, clear lavender flower of immense size and splendid substance.

Light-in-the-Opal. Double; orchid-pink with glistening sheen.

Mahogany Giant. Deeper shade of velvety maroon than mahogany, and larger.

Violet Giant. Rich violet; semi-double; frequently 27 inches in circumference.

White Giant. White with yellow markings.

Above Improved Irises, \$1 each, \$2.90 for 3, \$11 per doz.

STANDARD VARIETIES.

Blue Queen. Deep blue, veined yellow.

Mrs. George Stump. Single; white with lavender center.

Painted Lady. Single. A beautiful combination of pink and white.

Pyramid. Tall. Dark violet-purple, yellow blotch.

Violet Beauty. Deep violet; single.

All Standard Irises, 55 cts. each, \$1.50 for 3, \$5.50 per doz.

IRIS PUMILA. *Dwarf Iris.* Lovely little Iris only 8 inches high. Blooms in April and May. Useful for the rock-garden; can also be used for edging.

Excelsa. Pale lemon-yellow.

Sambo. Dark violet-blue.

Schneekuppe. A large showy white.

All above Iris, \$1.30 for 3, \$5 per doz.

IRIS CRISTATA. *Crested Iris.* Large crested soft amethyst-blue with a touch of gold. May. 4 to 6 in. \$1.30 for 3, \$5 per doz.

Spring and Fall Blooming Iris

This splendid group has evoked great interest in the garden world because after flowering profusely in the spring they blossom again in the fall, after they have become well established.

Autumn Elf. Standards are cream, falls lavender. Very fragrant. 1½ ft.

Autumn King. Blue-purple of good substance. 3 ft.

Autumn Queen. A very pretty white, dwarfier than the King.

Dorcas Hutchinson. Very fragrant; deep violet self. Of great merit. 1½ ft.

Peggy Babington. Rich clear canary-yellow. 28 in.

Sangreal. Rich yellow. 28 in.

September Skies. Purple-red. Excellent companion to Golden Harvest. 16 in.

COLLECTIONS

1 each of the above 7 varieties, \$2.90.

3 each of the above 7 varieties, \$8.50.

IRIS SIBIRICA • *Siberian Iris*

They make large clumps of decorative grassy green foliage and produce an abundance of flowers excellent for cutting. 3½ to 4 ft. June.

Emperor. A dark violet-blue.

Perry's Blue. Clear sky-blue.

Snow Queen. Pure white.

All above Iris, \$1.30 for 3, \$5 per doz.

MINIATURE IRIS

An early dwarf type, blooming along with the daffodil. Beautiful and delicate in appearance, yet especially hardy. Recommended for the rock-garden, for edging the border or alongside the garden path.

Fautleroy. Standards white edged soft yellow; falls purple edged yellow. 6 in.

Mogador. Milk-white standards; falls soft yellow. 12 in.

Rose Mist. Soft rose-lilac. 10 in.

Sound Money. Rich golden yellow. Blooms spring and fall. 8 in.

Tampa. Brilliant mulberry-red. 1 ft.

All above Iris, \$1.30 for 3, \$5 per doz.



Iris cristata



Bearded Iris

IRIS VULGARIS

Bearded Iris; Flag; Fleur de Lys

These beautiful flowering plants are one of the mainstays of the garden. They are all of easy culture, simply requiring a well-drained soil and plenty of sun. Care should be taken not to plant too deep.

Ambassadeur. Standards rosy lilac; falls rich purple.

Athene. Tall bearded white.

Dauntless. Velvety near red. 40 in.

Dazzler. Deep rose; very fragrant.

Euphony. Yellow; falls flushed blue. 3 ft.

Evolution. Tall bearded, self yellow.

Grisette. Pleasing blend of violet, old-gold and light brown.

Grace Sturtevant. Rich mixture of dark red, brown, and violet-carmine, with a velvety finish on the falls. A striking feature of this flower is the prominent bright golden beard.

Henri Riviere. An excellent flower in delicate shades of soft yellow and pale lilac-mauve. The lilac shading is very delicate, so that the general effect is yellow. 3½ ft.

Indian Chief. Classified as one of the superior reds; it carries a bronzy overcast. Very large flower, quite tall, and well branched.

Midgard. Fine yellow variety with a suffusion of pink.

Milky Way. Milk-white, veined light lavender. Beautiful indeed.

Mrs. Valerie West. Brown-red and crimson; large, fragrant flower. 3 ft.

Pioneer. Rich red-purple.

Queen Catherine. Very large, pale blue flowers. Sweetly scented.

Rameses. Combination of rose, pink, and buff. 3 ft.

Seminole. Velvety red-purple with a bright orange beard.

All above Iris, \$1.30 for 3, \$5 per doz.

HEMEROCALLIS

Daylily

Graceful, grass-like foliage sets off the fragrant lily-like flowers. We offer varieties blooming from May until July. After each variety is the date on which our first blooms appear. Flowering period is from 4 to 6 weeks.

Francis Marion Series. Loviest reds, wines, maroons and purples, bold patterns, with no yellows or orange. Varied blooming season gives several months of brilliant color. \$1.25 each, \$3.50 for 3, \$13.50 per doz., \$100 per 100.

SUNSHINE SERIES

Many people prefer the paler tints of lemon and gold, and to enable our customers to have some of the better new varieties in these light colors at a moderate price we have selected this Sunshine series. They include some of the finest sorts ever produced in these particular colors, to be sold unnamed and unlabeled, in mixture only. 55 cts. each, \$1.50 for 3, \$5.50 per doz., \$40 per 100.

JACOB MURRAY SERIES

These hybrids are made up of all the darker colored varieties so desired by everyone. They range in color from dark maroons, mahogany, rose, to tan and many bicolors. All are unusual colors and vary as to height and time of bloom. They are a definite addition to your perennial border. 65 cts. each, \$1.90 for 3, \$7.25 per doz., \$52.50 per 100.



Hemerocallis

New Dwarf Hemerocallis

The following are low-growing plants, averaging no more than 18 to 24 inches. Perfectly hardy and of easy culture, they bear hundreds of flowers each season when once established. Excellent for edging borders, paths, and driveways.

Dumortieri. Bright yellow, shaded brown. May, June.

Middendorffi. Bright yellow-orange. June, July.

Orangeman. Beautiful orange-yellow. Early June.

Above, 65 cts. each, \$1.90 for 3, \$7.25 per doz.

NAMED HEMEROCALLIS

***Bay State.** Large; orange. 3 ft. June 25. 55 cts. each, \$1.50 for 3, \$5.50 per doz.

***Dover.** Large; gold. 2½ ft. May 25. 55 cts. each, \$1.50 for 3, \$5.50 per doz.

Dr. Regel. Rich orange-yellow; fragrant. 2 ft. May 20. \$1.20 for 3, \$4.75 per doz.

***George Yeld.** Large; golden yellow with brown suffusion. 3½ ft. July 1. 55 cts. each, \$1.50 for 3, \$5.50 per doz.

Gold Dust. Orange. 2½ ft. May 25. \$1.20 for 3, \$4.75 per doz.

Goldem. Golden yellow. 3 ft. June 8. \$1.20 for 3, \$4.75 per doz.

***Gypsy.** Very deep orange. 4 ft. June 17. 55 cts. each, \$1.50 for 3, \$5.50 per doz.

Hyperion. Citron-yellow. Considered the finest. 3½ ft. \$1 each, \$2.90 for 3, \$11 per doz.

***J. A. Crawford.** Fine apricot-yellow. 4 ft. June 17. 55 cts. each, \$1.50 for 3, \$5.50 per doz.

Mikado. *New.* Rich orange, purple shading. 75 cts. each, \$2.15 for 3, \$8.25 per doz.

Ophir. Tall; lemon-yellow. 4 ft. June 25. 55 cts. each, \$1.50 for 3, \$5.50 per doz.

***The Gem.** Pale gold. 3 ft. June 15. 55 cts. each, \$1.50 for 3, \$5.50 per doz.

COLLECTIONS

1 plant each of the above 6 varieties marked*, \$3

3 plants each of the above marked*, \$8.75

BY ALL MEANS—Plant Strawberries

Well-drained soil is a requisite for Strawberries. They will not do well in a stiff clay; sandy loam is ideal, with a plentiful supply of moisture at all times. Select potted plants and space them at 9 to 12-inch intervals in rows 2 feet apart in spring or late summer. The potted plants which we offer have been established from late fall runners. They are fine strong specimens, ready to take hold as soon as they are transplanted to your garden.

The soil where Strawberry plants are to be set out should be carefully prepared ahead of time. Plow or spade it to a depth of 6 to 8 inches. Then with a rake, smooth and level it off to form a bed.

Set the plants out on a cool cloudy day if at all possible. In case of hot sunny weather after they are planted, shade them until the roots take hold. Place them at the same depth at which they were in the pot—with the bud just at the surface of the ground. Keep the row well weeded at all times, but when hoeing remember that the roots are very close to the surface. It is a good plan to spread about ½ inch of peat moss under the plants in December, as winter protection. When spring comes, it can be brushed under the plants to conserve moisture in the soil and to keep the berries clean.

Early

FAIRFAX. One of the very top varieties for family gardens and roadside markets because of its superb flavor and dark red berries. Sturdy, attractive plants with large, dark green leaves. Produces a good crop of blocky, rich red berries that are popular everywhere.

PREMIER. The best early Strawberry. It does well on any soil and even under unfavorable conditions will make a splendid crop. The berries are beautiful in appearance, having uniform shape and a glossy, rich red color that extends through the whole berry. Delicious flavor. We cannot recommend Premier too highly.

Potted Plants, \$2.50 per doz., \$4.50 for 25, \$15 per 100



Strawberries, Big Joe

Midseason

BIG JOE. Extremely large, beautiful berries with large, bright green calyx. One of the best in flavor. Succeeds in almost all soils and under all conditions, and is therefore a valuable sort. A good producer, mid-season to late.

CATSKILL. Does especially well in the northern states. Can be depended on for a big crop of big berries in midseason. Fine quality and flavor; pleasing light red color, making them very showy. Firm enough for shipping short distances. Vigorous, healthy plants.

Potted Plants, \$2.50 per doz., \$4.50 for 25, \$15 per 100

Everbearing

The following types produce flowers rather sparingly all season. By keeping them pinched off in spring and summer until August 15, and so building up reserve strength in the plant, a fair crop of good fruit will be developed for the autumn.

MASTODON. The most popular everbearing sort. Needs plenty of moisture all summer but not especially rich land. The strong, rugged plants can be depended on for a crop under almost any conditions. Large, bright red berries in spring as well as fall.

PROGRESSIVE. Medium-sized berries of full flavor are produced all season.

Potted Plants, \$2.75 per doz., \$4.75 for 25, \$17.50 per 100

Hardy Perennial Plants Produced In Our Own Garden

Fall Anemones • Windflower

Thriving in sun or partial shade, they produce a charming picture from early September to late October. They revel in a woody soil, i.e., rotted leaves, peat, etc.

***Alice.** Large, semi-double, rose-pink. Strong grower. 2 to 2½ ft.

Huopenhensis. Early. Rose-mauve. 1½ ft.

***Marguerite.** Double, dark pink. 3 ft.

***Marie Mauchard.** Semi-double, white. 3 ft.

Queen Charlotte. Beautiful, large silvery rose flowers. 3 ft.

Rosea superba. Large rose flowers. 3 ft.

September Charm. Rosy pink. Very floriferous and popular. 2 ft.

***September Queen.** A gem. Semi-double rose-red. Very floriferous. 2 ft.

Rubra. Dark crimson. 2 ft.

***Whirlwind.** Pure white, double. Very strong variety. 2½ ft.

Above Anemones, 55 cts. each, \$1.50 for 3, \$5.50 per doz.

COLLECTIONS

5 plants, one each marked *, \$2.25; 15 plants, 3 each, \$6.50

ARMERIA. Thrift; Sea-Pink.

Bees' Ruby. Large flowers are borne on long stems. Color is brilliant ruby-red 1½ ft. May-Sept. 55 cts. each, \$1.50 for 3, \$5.50 per doz.

Campanula • Bellflower

These beautiful plants are for the rockery and border. They are of easy culture.

Carpatica. ★ A compact-growing plant 6 inches high. Large clear blue flowers. July.

Carpatica alba. ★ White twin of the above.

Garganica. ★ Trailing habit. Covered with deep blue, starry flowers in July.

DIANTHUS. Garden Pinks. Plants of compact habit with fragrant flowers.

Beatrix. ★ Light salmon-pink, exquisitely scented flowers from May to Nov. 9 in.

Bobby. ★ A gem; deep pink flowers, each with a crimson ring in the center.

Her Majesty. ★ Large pure white, intensely fragrant flowers. 1 ft. June.

Little Joe. ★ Flowers all summer and fall. Beautiful gray-green foliage, with large single rich crimson flowers. 55 cts. each, \$1.50 for 3, \$5.50 per doz.

New Blue. ★ Foliage is dark green. Flowers lavender-blue, resembling a sweet william, and profusely borne on 9-inch trusses. July-Sept. 55 cts. each, \$1.50 for 3, \$5.50 per doz.

Scotch or Florists' Pinks. ★ Wide color-range; single and double. 1 ft. June.

Silvermine. ★ Novelty. Like Beatrix except that the flowers are pure white.

HEDERA Helix. English Ivy. ★ Fine for under trees, on banks or against walls. 2¼-in. pots, 1-ft. runners, \$2.75 per doz., \$21.50 per 100; 3-in. pots, 2½-ft. runners, 55 cts. each, \$1.50 for 3, \$5.50 per doz., \$42.50 per 100; 4-in. pots, 3½-ft. runners, 75 cts. each, \$2.15 for 3, \$8.25 per doz.

LYCHNIS splendens fl.-pl. ★ A wonderful plant making a tuft of grassy foliage from which arise stiff stems, smothered with large, double, and extremely beautiful rose-pink flowers in great profusion. 15 in. 55 cts. each, \$1.50 for 3, \$5.50 per doz.

Myosotis • Forget-me-not

Palustris semperflorens. ★ It is of creeping habit and flowers from June until September. The florets are of a beautiful clear pale blue with small yellow eyes. 6 in.

PACHYSANDRA terminalis. Oriental Spurge. Fine ground-cover for shade or semi-shade. Its bright glossy green foliage is invaluable for bordering walks and drives. It is often used with success under trees where nothing else will grow. For quick results, plant 9 inches apart. Height 6 to 9 in. Plants from 3-in. pots, \$2.75 per doz., \$21.75 per 100; 2-yr. field plants, \$2.50 per doz., \$19.75 per 100, \$185 per 1000.

SANTOLINA. Lavender Cotton; Ground Cypress. ★ Dwarf sub-shrubs which hold their leaves in winter. They are excellent for edgings or for the rock-garden, and can be clipped every year. The foliage is most attractive and very aromatic.

Incana. Very compact, with beautiful silvery gray foliage with the appearance of bunched coral. Yellow flowers in July. 6 to 9 in.

SEDUM • Stonecrop

Foundation of many early rock-gardens, and no rock-garden today is complete without some of the species mentioned.

Acre. ★ Green foliage. Bright yellow flowers. 3 in. June.

Balticum. ★ 3 in. June.

Dasyphyllum. ★ Rose. 3 in. June.

Lydiium. ★ Pink. 2 in. June.

Middendorffianum. ★ Excellent matting variety, 4 inches high, with yellow flowers. Beautiful reddish purple foliage in autumn.

Nevi. ★ Blue-gray rosettes. 4 in. July.

Sieboldi. ★ Rose-pink. 9 in. Aug.

SEMPERVIVUM. Houseleek; Live Forever. ★ Evergreen succulents resembling Sedums. The leaves are often brightly colored at the base.

Arachnoideum. Cobweb Houseleek. A beautiful plant. The round masses of leaves are always covered with a white cobwebby substance, giving it a most unusual effect. 2 in.

Globiferum. Grass-green rosettes tinged with red. Yellow flowers in August. 3 to 4 in.

Mixed Seedlings. Choice selection of all shapes and sizes. 3 to 4 in.

SILENE. Catchfly; Champion.

Schafta. ★ One of the best autumn-flowering rock-plants. It blooms in October when flowers are scarce in the rockery. A compact plant with bright rose-pink flowers. 6 in.



Vinca (Periwinkle)

THYMUS • Thyme

★ These charming, fragrant plants are mostly of dwarf, spreading habit and are unexcelled for dry, sunny banks where grass is difficult to establish, and for various positions in the rock-garden. When planted in the crevices of walks, they give off a fragrant aroma when walked on, and are a sheet of blossoms in June and July.

Lanuginosus. Mauve flowers and gray, woolly leaves. 2 in. June.

Serpillum. The wild Mountain Thyme of creeping habit, with rosy purple flowers. 2 in. June.

Serpillum albus. Decidedly miniature foliage of light bright green with pure white flowers. 1 in. June.

Serpillum coccineus. Very dark reddish green foliage, making a perfect mat like the above, but with brilliant crimson flowers. 1 to 2 in. June.

VERONICA • Speedwell

Free-flowering plants, for the rock-garden and border.

Incana nana. ★ A compact plant with beautiful silvery foliage and spikes of brilliant blue flowers. 6 to 9 in. July, Aug.

VINCA

Periwinkle: Old Maid; Myrtle ★

Grand ground-covers for shade.

Minor. Delicate blue flowers with glossy green foliage.

Minor alba. White flowers; dark foliage.

Minor, Bowles Variety. A greatly improved form. Always in bloom, the flowers being very large and clear blue.

Above Vincas, 50 cts. each, 3 for \$1.40, \$5.25 per doz.

HERBS

For the Kitchen Garden and for the formal fragrant, old-time Herb Garden

Chives. *Allium Schœnoprassum.* Mild onion flavor, used as a salad ingredient. 10 inches.

MINTS

Peppermint. *Mentha piperita.* True English. An essence is distilled and a medicinal tea is infused from Mint. For flavoring juleps. From it menthol is obtained. 3 feet.

Spearmint. *M. viridis.* The common garden Mint. For Mint sauce, julep, jelly, etc., and for flavoring vegetables in cooking. Leaves candied for sweetmeats. 2 feet.

Creeping Mint. *M. Requieni.* Miniature variety for planting in "crazy pavements." 8 inches.

THYMES

Citron or Lemon Thyme. *Thymus citriodorus.* Scented carpeting plant. A few leaves in tea will enhance the aroma. 10 inches.

Common Thyme (English Thyme). *T. vulgaris.* Broad leaves. For seasoning foods, including salads and wine. Excellent edging plant. 8 inches.

French Thyme. *T. vulgaris.* Dwarf, small-leaved, heath-like plant. Potpourri ingredient. Plant it to be walked on. 8 inches.

Tarragon (Estragon). *A. Dracunculus.* For salads and flavoring vinegar. Essential oil used in perfumery. 55 cts. each, \$1.50 for 3, \$5.50 per doz.

PRICES, unless otherwise noted, \$1.30 for 3, \$5 per doz., \$35 per 100. Purchaser pays transportation beyond 50 miles of N.Y.

★ Dwarf plants for the Rock-Garden and edging the Perennial Border

| | 3 for | Per doz. |
|---|----------------|-------------|
| Anchovy Strips. Delicious on fingers of toast with cocktails or cut up in mixed greens salads. 2 oz. tin | \$1 10 | \$4 25 |
| Anchovy Paste. Imported. Made only from imported Anchovies with a little salt added. 2 3/4 oz. jar | 1 20 | 4 60 |
| Anchovies Stuffed with Capers and Pimientos, in pure olive oil. 8 oz. jar | \$1.85 | 5 50 21 50 |
| Rolled Anchovies. Serve them on toast, as canapes. 2 oz. tin | 1 10 | 4 25 |
| Imported Antipasto. From Portugal. A real treat of delicacies for cocktails and snacks. 4 1/2 ozs. | 1 50 | 5 85 |
| Russian Caviar. The real imported Caviar. Fine for canapes and garnishing. 1 oz. \$1.65 | 4 85 | 19 00 |
| | 2 ozs. \$3.25 | 9 50 37 50 |
| | 4 ozs. \$6.50 | 19 00 75 00 |
| Chicken Liver Pate. A fine spread, ideal for sandwiches, hors-d'oeuvres and salads. 4 oz. glass jar | 1 40 | 5 50 |
| Whole Cod Liver. Imported delicacy, packed in tasteless cod liver oil. Unusual for canapes. 6 oz. tin | 2 45 | 9 70 |
| Crab Meat. Choice lumps of white meat, perfect for cocktails and salads. 6 1/2 oz. tin 90 cts. | 2 60 | 10 20 |
| Au Gourmet Cheese Sticks. 60 to tin \$1.25 each | | |
| Cocktail Franks. Tiny sausages made of pure ingredients and most flavorful. 33 pieces in 6 oz. jar | 1 95 | 7 60 |
| Deviled Smithfield Ham. New taste thrill for sandwiches and canapes. 3 ozs. | 1 00 | 3 90 |
| | 7 ozs. | 2 10 8 25 |
| | 16 ozs. \$1.60 | 4 70 18 50 |
| Louis Henry Pate de Foie Gras (Strasburg.) (French). No. 14 crock \$3.25 each | | |
| Mushroom Bordelaise. Spiced Mushrooms to heat and serve with steak or omelet. 7 ozs. | 1 50 | 5 75 |
| Smoked Mussels. Used as an hors-d'oeuvre. Served with your favorite drink. 3 1/4 ozs. | 1 90 | 7 40 |
| Smoked Oysters. At last it is back—the old favorite among gourmets. 3 1/2 ozs. | 2 50 | 9 85 |
| Pate de Foie with Truffles. A real delicacy for canapes. 7 oz. tin \$1.12 | 3 30 | 13 00 |
| Rattlesnake Meat with Supreme Sauce. Sweet, delicate meat in a superb sauce. 5 ozs. \$1.55 | 4 50 | 17 75 |
| Smoked Shad Pate. Highly flavored; for sandwiches. 3 1/2 ozs. | 1 00 | 3 85 |
| Pate of Smoked Rainbow Trout. Lovely new-tasting fish pate for cocktail spreads. 3 3/4 oz. tin | 3 00 | 11 75 |
| Norwegian Cocktail Shrimp. These little gems are imported and an added delicacy for cocktails and other uses. 3 ozs. | 1 95 | 7 50 |

OLIVES

| | | |
|---|------|-------|
| Martini Olives. Fine for your favorite drinks. 4 1/2 ozs. | 1 80 | 7 00 |
| Stuffed with Anchovies. 2 oz. tin | 1 20 | 4 65 |
| Half stuffed, half plain. 21 ozs. \$1.70 | 5 00 | 19 50 |
| Plain Queen. 12 3/4 ozs. \$1.05 | 3 10 | 12 25 |
| Plain Queen. 21 ozs. \$2.20 | 6 50 | 25 50 |
| Stuffed with Olives. 7 1/4 ozs. 75 cts. | 2 20 | 8 60 |
| Stuffed with Pimientos. 10 ozs. \$1.25 | 3 60 | 14 00 |
| Stuffed Queen. 22 ozs. \$2.30 | 6 75 | 26 50 |
| Colossal Black Ripe. 8 1/2 ozs. 75 cts. | 2 20 | 8 60 |
| Gargantuan ripe. Tremendous beauties. 15 ozs. \$1.50 | 4 25 | 16 50 |
| Gargantuan green. Like elongated ping-pong balls. 9 3/4 ozs. | 2 75 | 10 50 |
| Maraschino Cherries (without stems) for garnishing and cocktails. 28 ozs. \$1.85 | 5 50 | 21 00 |
| Cocktail Onions. For salads and drinks. 4 ozs. | 1 80 | 7 00 |
| Orange Slices. For many uses; not the least is to enhance an Old-Fashioned. 15 oz. jar | 1 70 | 6 70 |

| | 3 for | Per doz. |
|--|--------|----------|
| Chicken Almond Paste. 3 1/2 ozs. | \$1 35 | \$5 25 |
| Crab Paste 3 1/2 ozs. | 1 35 | 5 25 |
| Smoked Salmon Paste 3 1/2 ozs. | 1 35 | 5 25 |
| Smoked Turkey Sausage. Delectable smoked Turkey meat in the form of little sausages. 3 1/2 ozs. | 2 20 | 8 60 |

| | 3 for | per Doz. |
|-------------------------|--------|----------|
| Artichoke Hearts | \$2 00 | \$7 85 |
| Mushrooms | 2 00 | 7 85 |
| Egg Plant | 1 75 | 6 85 |
| Roasted Peppers | 1 60 | 6 25 |
| Antipasto | 1 50 | 4 25 |

Above all packed in 6 oz. jars with pure olive oil.

MARTIN'S WILD GAME

| | 3 for | Per Doz. |
|---|--------|------------|
| Pheasant Giblet Pate. Real delicacy to serve on toast with chopped eggs. \$1.50 each | \$4 40 | \$17 40 |
| Pheasant All Meat Pate. \$1.50 each | 4 40 | 17 40 |
| Whole Canned Pheasant. The whole delectable bird in its pure juices. Ready to eat; serve it cold or warmed, as you prefer. 3 lbs. \$7.00 | 23 50 | 92 00 |
| Canned Pheasant. Disjointed bird; delicious. Serve as is, or warmed. 1 3/4 lbs. \$6.50 | 19 00 | 74 50 |
| Wild Turkey Broth with Wild Rice. 10 1/2 ozs. | 1 85 | 7 15 |
| Wild Pheasant Broth with Wild Rice. 10 1/2 ozs. | 1 85 | 7 15 |
| Wild Turkey a la King. Unusual luncheon or supper dish. Just heat and serve on toast. 10 1/2 oz. tin | \$1.65 | 4 85 19 00 |
| Pheasant a la Newburg. For that unusual luncheon or late snack. A very distinctive flavor. 10 1/2 ozs. \$1.65 | 4 85 | 19 00 |

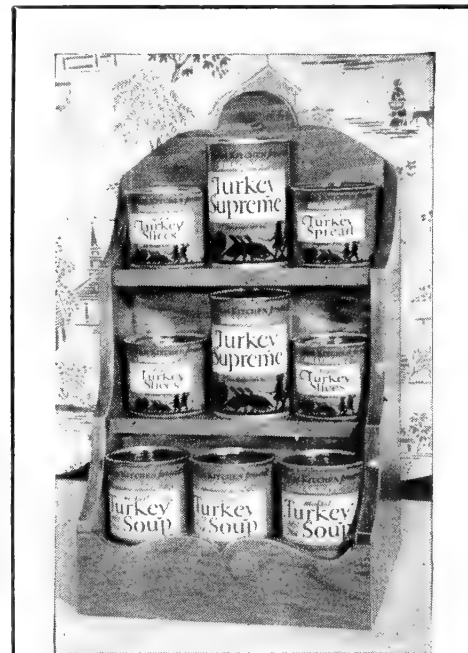

SHAGROY FARM TURKEY PRODUCTS

| | | |
|-------------------------------------|-------------|--------|
| Fresh Turkey Slices | 6 ozs. | \$0 90 |
| Smoked Turkey Slices | 6 ozs. | 1 50 |
| Smoked Turkey Split Pea Soup | 10 1/2 ozs. | 40 |
| Turkey Supreme | 10 1/2 ozs. | 95 |
| Smoked Turkey Spread | 6 ozs. | 95 |
| Turkey Noodle Soup | 10 ozs. | 35 |

FISH, FOWL, MUSHROOMS etc., at Their Best

| | 3 for | Per doz. |
|---|------------|------------|
| Artichoke Bottoms in Broth. For unusual salads. Packed in Paris. 6 pieces, 3 1/2 ozs. \$1.75 | \$5 00 | \$19 50 |
| Sea Bass. Solid meat. Packed in its own oil. 7 1/2 oz. tin | 1 75 | 6 75 |
| Boneless Chicken. The best of the meat, and all meat. Lb. \$2.45 | 7 25 | 28 50 |
| Chicken a la King. All ready to heat and serve on toast. 11 1/2 ozs. | 1 90 | 7 50 |
| Corn Beef Hash. A de luxe item. Nourishing, with a flavor that is astonishingly good. 16 ozs. | 1 75 | 6 75 |
| Smoked Silver Eel. A wonderfully flavored, real delicacy. 8 oz. tin | 1 50 | 5 75 |
| | 16 oz. tin | 2 75 10 50 |
| Escargots (Snails). Snail lovers will welcome these. 7 oz. tin \$1.35 | 3 90 | 15 00 |
| Frankfurters. The delicious imported style. Packed 6 to a tin. 14 ozs. \$1.10 | 3 20 | 12 60 |
| Lobster a la Newburg. A delightful supper and luncheon dish in rich sherry sauce. 13 oz. tin \$1.15 | 3 35 | 13 25 |
| Mushrooms Broiled in Butter. Ten to twelve large Mushrooms cooked and seasoned; use as garnish on meats, or on toast. 6 oz. tin | 1 85 | 7 25 |
| Chopped Mushrooms Broiled in Butter. Chopped stems and crowns of Fancy Mushrooms, broiled in fine rich creamy butter. 3 oz. tin | 90 | 3 40 |
| Sliced Mushroom Crowns Broiled in Butter. Sliced fancy Mushroom crowns. 3 oz. tin | 1 05 | 4 00 |
| Whole Ox Tongue. One whole Ox Tongue ready for eating. Fine for sandwiches, etc. 1 lb. \$1.75 each | 5 00 | 19 50 |
| Hearts of Palms. The inside of the palm tree. A rare Brazilian salad. 26 oz. tin \$1.85 | 5 15 | 20 00 |
| Salmon. Fancy Columbia River Salmon Steaks. 1 solid piece in oval tins. 15 oz. tin \$1.15 | 3 30 | 13 00 |
| Smoked Blueback Salmon. A mild smoking makes this delicious fish so unusual for salads and hors-d'oeuvres. 7 oz. tin | 2 40 | 9 40 |
| Fancy White Tuna (Solid Pack) In oil. 7 oz. tin | 2 10 | 8 25 |
| French Sardines in Olive Oil. Yacht Club Brand packed by Rene Beziars. 4 3/4 oz. tin | 2 85 | 11 00 |
| Spanish Boneless Sardines packed in pure olive oil. 3 3/4 oz. tin | 1 40 | 5 40 |
| Portuguese Sardines. Skinless and boneless. 3 3/4 ozs. | 1 40 | 5 40 |
| Norwegian Sardines. This flavorful Sardine is again available, packed in oil. 3 3/4 oz. tin | 1 20 | 4 50 |
| Shad Roe. Two perfect Roes in their own broth. 7 1/2 oz. tin \$1.10 | 3 20 | 12 50 |
| Jumbo Shrimp (Louisiana). Again this choice item is back. Jumbo size. 5 oz. tin 85 cts. | 2 45 | 9 60 |
| Iceland Brook Trout. Three or four Trout in tin ready for broiling or frying. 8 oz. tin \$1.25 | 3 60 | 14 10 |
| Turkey a la King. Simply heat; then serve on toast. 16 ozs. | 2 50 | 9 75 |
| Smoked Turkey Slices. Keep several jars on your pantry shelf, and enjoy often. 7 ozs. 90 cts. | 2 60 | 10 00 |
| Green Turtle Meat. Delectable meat for your favorite turtle recipe. 2 lbs. 4 ozs. \$2.75 | 8 10 | 31 90 |
| Welsh Rarebit. Made from finest Cheddar Cheese, properly seasoned. Just heat and serve on toast. 12 oz. jar | 1 90 | 7 50 |
| Wild Rice. For serving with all game and fowl. Lb. box \$1.75 | 5 10 | 20 25 |
| Snack Bar package. For hors-d'oeuvres or a quick snack. Unique gift, or a practical addition to the reserve shelf. Contains Smoked Turkey, Sausage, Chicken Liver, Crab Paste, Wafers, Opener, Coasters, Picks and Spreaders. \$2.25 | | |

DELICIOUS CHINESE FOODS

| | | |
|--|--------------|------------------|
| Bamboo Shoots. Tender, decorative morsels, used in many oriental dishes. 13 ozs. \$1.15 | 3 for \$3 25 | Per doz. \$12 75 |
| Lichee Nuts. Flavor is sweet and unusual. ½ lb. \$1.00 | 2 90 | 11 50 |
| Water Chestnuts. We offer them shelled, skinned and ready for use. 13 ozs. \$1.00 | 2 90 | 11 50 |
| Following two are the finest quality Canton Ginger. In ½-lb. sealed tins: | | |
| Crystallized Ginger. Favorite confection. Processed in Hong Kong. \$2.00 | 5 75 | 22 50 |
| Ginger-Sherry Sauce. Rare dessert topping. Processed in the U. S. \$1.00 | 2 90 | 11 50 |
| Chum-bits. Toasted Sweet Rice Cakes. 5 oz. jar | 1 75 | 6 75 |
| Rice Cakes. (30 pieces). The original Tea Cake. 7 oz. pkg. | 1 80 | 7 00 |
| Fortune Teller Rice Cakes (16 pieces). 3 ½ oz. pkg. | 1 35 | 5 25 |

SAUCES AND RELISHES

| | | |
|--|------|---------|
| East India Curry Sauce. A concentrated sauce for curried dishes. Try it especially with shrimp, lamb or chicken. 10 oz. jar | 2 60 | \$10 25 |
| Arti Chow. A real chow-chow with artichoke chips added. 16 oz. jar | 1 19 | 4 30 |
| Imported Indian Mango Chutney Sauce (Green Label). 9 oz. jar | 1 65 | 6 50 |
| Major Grey's Chutney Gold Label (Ship's Brand). Packed in India. 1 lb. jar \$2.00 each | 5 75 | 22 50 |
| Major Grey's Chutney (Imported) Splendid with curried dishes and summer meals. 10 ozs. \$1.35 each | 3 90 | 15 00 |
| Chutnut. Delicious with roasts, fowls, curries, sandwiches. 10 ozs. | 1 50 | 5 75 |
| Mustards, French Type. From an old Dijon formula. Three flavors: Sharp, Tarragon, Tomato. 5 ozs. 60 cts. | 1 75 | 6 75 |
| Old Fashioned Whole Cranberry Sauce, made from an old family recipe. 1 lb. tin | 1 20 | 4 60 |
| New Hampshire Watermelon Rind (Greig's). A favorite at St. Paul's School. 1 lb. jar | 2 25 | 8 75 |
| Pimiento Slices. For use in garnishing and in various cream dishes. 6 oz. jar | 1 00 | 3 90 |

DIXIE DAME PICKLES

Dixie Dame home-prepared delicacies are unusual. Attractive on the cocktail tray or for buffet meals. They are all hand made.

| | | |
|--|--------------|------------------|
| Olive Style. Pickled burr gherkins stuffed with pimientos. Sour-sweet. 8 ozs. 90 cts. | 3 for \$2 60 | Per doz. \$10 25 |
| Stuffed Rings. Cucumber rings, pimiento-stuffed. 8 ozs. 90 cts. | 2 60 | 10 25 |
| Midgit Dills. Small pickled gherkins, dill-flavored. 8 ozs. 75 cts. | 2 15 | 8 45 |
| Polka Dots. White artichoke balls stuffed with capers and pimientos, lovely garnish. 8 ozs. 90 cts. | 2 60 | 10 25 |
| Acorns. Pickled burr gherkins stuffed with almonds. Sweet-sour. 8 ozs. 90 cts. | 2 60 | 10 25 |
| Red Buds. Pickled burr gherkins, cherry-stuffed. 8 ozs. 90 cts. | 2 60 | 10 25 |
| Moonstones. Onion-stuffed gherkins. Sweet-sour. 8 oz. 90 cts. | 2 60 | 10 25 |
| Old Fashioned. Small artichoke tubers, decorated with pepper. A southern pickle. 12 ozs. 75 cts. | 2 15 | 8 45 |
| Wild Rose Design. Made from old recipe. Cross cut in thin slices, for open sandwiches. 8 ozs. 90 cts. | 2 60 | 10 25 |
| Baby Beets. With tiny onions. 12 ozs. 75 cts. | 2 15 | 8 45 |
| Crisp Cartwheels. Crystallized green tomato slices. Crisp and brittle. 12 ozs. 90 cts. | 2 60 | 10 25 |
| Porcupines. Sweet gherkins stuffed with relish and held together with toothpicks. 12 ozs. 90 cts. | 2 60 | 10 25 |
| Cocktail Sweet Pickled Wafer Sticks (Pickles). 10 ozs. | 1 50 | 5 85 |

VINEGARS

| | | |
|---|--------------|-----------------|
| Pineapple Vinegar. An unusual Vinegar from the Hawaiian fruit, bottled in California. 16 ozs. \$0 80 | 3 for \$0 80 | Per doz. \$3 10 |
| Malt Tarragon Vinegar (True French Flavor). 16 ozs. 1 15 | 1 15 | 4 50 |

OILS

| | | |
|---|---------------|---------------|
| Suitable for salads, cooking and frying. pure. Packed in one pint tins. | | |
| | Each 3 for | 100% Per doz. |
| Almond. | \$2 25 \$6 50 | \$25 50 |
| Avocado. | 2 00 5 75 | 22 50 |
| Epicurean. | 1 50 4 35 | 17 00 |
| Pure Olive Oil, Dante Brand. | | |
| Packed in Italy. ½ gal. \$6.00 | | |
| 1 gal. \$10.00 | | |
| Pure Olive Oil, Di Nola Brand. | | |
| 1 pt. 1 75 5 00 19 00 | | |

SUPERB WINE DRESSINGS

| | | |
|------------------------------------|--------------|-----------------|
| Sherry Wine. 16 ozs. \$1 35 | 3 for \$5 25 | Per doz. \$5 25 |
| Sauterne Wine. 16 ozs. 1 25 | 1 25 | 4 85 |
| Burgundy Wine. 16 ozs. 1 25 | 1 25 | 4 85 |

ROQUEFORT CHEESE SALAD DRESSING

Made from imported olive oil, herbed white wine vinegar, various seasonings and GENUINE ROQUEFORT CHEESE from France. The exquisite flavor makes a salad the high point of the meal. Pint jar \$2.00, 3 for \$5.75, \$22.50 per doz.

READY-TO-SERVE SOUPS

| | | |
|---|--------------|-----------------|
| Black Bean Soup. With Sherry Wine. 20 ozs. \$0 80 | 3 for \$0 80 | Per doz. \$3 10 |
| Consomme Madrillene. A fine Beef soup, with an entrancing flavor. 14 ozs. 90 | 14 90 | 3 40 |
| Lobster Bisque. 13 ozs. 1 75 | 1 75 | 6 75 |
| Onion. Real Parisian flavor. 32 ozs. 2 00 | 2 00 | 7 75 |
| Green Turtle Consomme. 13 ozs. 1 05 | 1 05 | 4 00 |
| Turtle with Meat. 32 ozs. \$1.75 | 5 00 | 19 50 |
| Vichysoisse. The Parisian potato soup. 13 ozs. 1 20 | 1 20 | 4 60 |
| Sinapore Mulligatawney with Sherry | | |
| Arabian Chervah with Sauterne Wine. | | |
| Danish Gule Arter (Pork Pea) | | |
| Aztec Black Bean with Sherry Wine | | |
| Bavarian Mushroom-Barley with Claret | | |
| Genoise Minestrone with Chianti | | |
| Odessa Cucumber-Meat with Chianti | | |
| Basque Onion with Burgundy | | |
| Viennese Beef Goulash with Claret | | |

All the above 9 varieties in 10 oz. tins. 3 for \$1.35. \$5.25 per doz.

DRINKS, BITTERS, MIXERS

| | | |
|---|--------------|------------------|
| Angostura Bitters. 8 ozs. \$1.58 | 3 for \$4 70 | Per doz. \$18 75 |
| Orange Bitters. 4 ozs. 1 85 | 1 85 | 7 30 |
| Raspberry Syrup. 12 ozs. 1 75 | 1 75 | 6 90 |
| Grenadine. 16 ozs. 2 10 | 2 10 | 8 15 |



Plums in Heavy Rum

SWEET CRACKERS, BISCUITS FRUIT CAKE AND COOKIES

| | | |
|--|--------------|------------------|
| Butter Cookies. These have a delicious rich, melting flavor. 2 lb. box \$1.65 | 3 for \$4 80 | Per doz. \$18 60 |
| Chocolate Filbeaux. (Frou frou.) Fine chocolate wafers filled with hazel nuts and covered with chocolate. 10 pieces to a box. \$1.25 each | 3 60 | 14 25 |
| Chocolate Thins. (Carlsbader Oblaten). Two chocolate wafers filled with chocolate. 60 pieces. \$1.50 each | 4 40 | 17 50 |
| Champagne Biscuits. \$1.50 each | 4 40 | 17 50 |
| Viennese Confectioner's Cookies. Something new and sprightly for the party. Really "Petits Fours." Lb. \$3.25 | 4 25 | 16 75 |
| Scotch Oat Cakes. Imported. 8 ozs. Lb. \$1.45 | 1 20 | 4 60 |
| Scotch Short Bread. Imported. 8 ozs. 1 20 | 1 20 | 4 60 |
| Vanilla Thins. (Carlsbader Oblaten). 60 pieces. \$1.50 each | 4 40 | 17 50 |

DELICACIES, CANDIES, SWEETS AND NUTS

| | | |
|--|----------------|------------|
| Allen's Toffee. (Famous in England since 1860.) 28 ozs. \$1.25 | \$3 65 | \$14 00 |
| Almondola. Superb sugared almonds with heavy chocolate coating. Lb. \$1.50 | 4 40 | 17 40 |
| French Sherry Pralines. A favorite candy at the court of Empress Eugenie. 8 ozs. \$1.25 | 3 60 | 14 00 |
| Napoleon Rum Cakes. Miniature cakes from an old recipe that uses rum, fruit and nuts. 12 ozs. \$1.85 | 5 40 | 21 00 |
| Baba-au-Rum. A delicious cake thoroughly soaked in rum sauce. 14 oz. tin \$1.15 | 3 25 | 12 75 |
| Wallace's Chocolate Wafer Thin Mints. They are delightful square mints packed in individual glassine bags. Lb. box \$1.45 | 4 25 | 16 75 |
| | 11 ozs. \$1.00 | 2 90 11 40 |
| Almond Roca. America's finest confection. Smooth milk-chocolate coats the almond-filled centers and toasted almonds top every piece. Gold-foil wrapped and vacuum-packed in decorated tin. Lb. \$1.75 | 5 15 | 20 25 |
| Wallace's Regent Chocolates. Superb continental style chocolates with a select variety of centers in miniature. Lb. box \$2.75 | 8 00 | 31 00 |
| Wallace's Selected. A new package of delicious assorted sample Chocolates; with candies, nougat and Jordan almonds. Lb. \$1.65 | 4 85 | 19 00 |
| Crepe Suzettes. Real French Suzette of finest ingredients rum-soaked; heat and serve. 16 ozs. \$2.00 | 5 85 | 23 25 |
| Maple Sugar Bricks. Lb. brick \$1.25 | 3 60 | 14 25 |
| Vermont Maple Syrup. (Gold Cup.) 12 oz. jar 60 cts. | 1 75 | 6 85 |
| Mixed Nuts in Sherry Wine. Fine over desserts. 14 ozs. \$1.75 | 5 15 | 20 25 |
| Plums in Heavy Rum. This fancy fruit was aged for one year in heavy rum and then jarred. A rare treat. 15 ozs. \$1.50 | 4 25 | 16 50 |
| Dates Whole in Brandy. To be used for extra delight with many kinds of desserts. 14 oz. jar \$1.60 | 4 60 | 18 00 |
| Brandied Peaches. | | |
| Brandied Pears. | | |
| Brandied Apricots. Above three, each, 18 ozs. \$1.20 | 3 50 | 13 75 |
| Brandied Ping Cherries. | | |
| Brandied Royal Ann Cherries. Above two, each, 18 ozs. \$1.35 | 4 00 | 15 50 |

DELLA ROBBIA MINTS

In every pound box of Della Robbia Mints—38 individual pieces, beautifully hand-tinted. Lb. \$1.25. 10-oz. Round Transparent Gift Package, \$1.00.

HONEY

| | | | | |
|--|-------------------|----------|--------|---------|
| Table Honey. Fine Blended Central American kinds, absolutely pure, packed in special dripless server. 24 ozs. \$1.50 | 3 for | Per doz. | \$4 25 | \$16 00 |
| Churned Honey. Soft velvety spread. Fine on toast and waffles. 1 lb. jar | 1 80 | | 7 00 | |
| California Orange Blossom. 12 oz. jar | 1 65 | | 6 40 | |
| New York State Clover Blossom. 1 lb. jar | 1 65 | | 6 40 | |
| Wild-Flower Honey in Quaint Smoky Mountain Pottery Jugs. Gaily colored, beautifully hand-made jugs filled with superb Wild-Flower Honey. Grand gift for week-end hostess. 16 oz. jug \$1.75 | 5 00 | | | |
| | 24 oz. jug \$2.25 | | 6 50 | |

DESSERT TOPPINGS

For enhancing the flavor of cakes, ice creams, etc.

| | | |
|---|--------|--------|
| Chocolate Butter Fudge. 15 ozs. | \$1 30 | \$5 00 |
| Butterscotch Fudge. 15 ozs. | 1 30 | 5 00 |
| Chocolate Syrup. 15 ozs. | 70 | 2 60 |
| Melba Sauce. Made from raspberries; pure. Ideal for topping puddings, ice cream, etc. 8 ozs. | 1 85 | 7 25 |
| Neselro. A fine dessert sauce rich in nuts and fruits. 10 ozs. | 2 10 | 8 00 |
| Delectable Creme d'Apricot, Creme de Cherry, Creme de Cocoa. The above three dessert sauces are of superb flavor. Contain 12% alcohol. 12 oz. bottle | 3 90 | 15 50 |

SAUCES IN GLASS

| | |
|---|--------|
| Peppermint Scotch Ice Cream Sauce | \$0 55 |
| Black Horse Special Ice Cream Sauce | 55 |
| Raspberry Ice Cream Sauce | 55 |
| Rum Sauce (For Ice Cream and Crepe Suzettes) | 1 00 |
| Brandied Cherry Sauce | 1 10 |

All of the above in ½ pints
Above Collection of five \$3.75 each

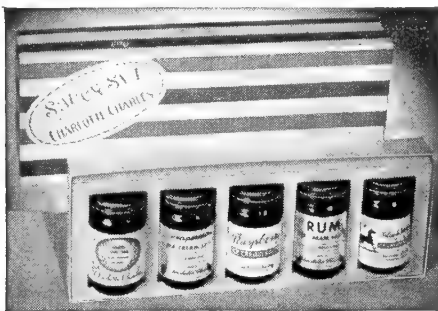

JAMS, PRESERVES

| | | | |
|---------------------------|---------|--------|--------|
| Lingon (Tyttebaer) | Lb. | \$1 40 | \$5 40 |
| Peach | Lb. | 1 20 | 4 60 |
| Apricot-Pineapple | Lb. | 1 40 | 5 40 |
| Apricot | Lb. | 1 20 | 4 60 |
| Plum | Lb. | 1 05 | 4 00 |
| Raspberry | Lb. | 1 90 | 7 40 |
| Strawberry | Lb. | 1 90 | 7 40 |
| Cashew Fruit | 13 ozs. | 3 50 | 13 50 |

JELLIES

| | | | |
|--------------------|-----------|------|------|
| Mint | 12 ozs. | 1 05 | 4 00 |
| Crabapple | 12 ozs. | 1 05 | 4 00 |
| Grape | 12 ozs. | 1 05 | 4 00 |
| Blackberry | 12 ozs. | 1 40 | 5 40 |
| Strawberry | 12 ozs. | 1 90 | 7 40 |
| Guava | 12 ozs. | 1 05 | 4 00 |
| Calves Foot | 13 ½ ozs. | 1 50 | 5 85 |

MARMALADES

| | | |
|--|--------------|-----------------|
| Roger Bently Bittersweet Orange Marmalade. 16 ozs. | 3 for \$1 50 | Per doz. \$5 85 |
| Ticklers Bitter Orange (Packed in England) | 1 85 | 7 25 |
| Guernsey House Marmalades made of pure fruits and sugar. Available in popular small size. No commercial pectin used. Attractively packed in decorative 11 ½-oz. jar. Makes an ideal gift. | | |
| Orange | 70 cts. each | 3 for \$2 05 |
| Bitter Orange | 85 cts. each | 2 50 |
| Grapefruit | 70 cts. each | 2 05 |
| Orange and Cherry | 70 cts. each | 2 07 |

TEA TASTER TEAS

We bring back these famous Named Teas; each different, with its own superior flavor.

| | | |
|---|--------|--------|
| | ½ lb. | Lb. |
| Assam. Rich and stout; colors up a strong red in the cup. | \$1 15 | \$2 00 |
| Jasmine. Flowery China Tea | 1 85 | 3 40 |
| Darjeeling. Perfect rich flavor. From the high Himalayas. | 1 15 | 2 00 |
| Choice Ceylon. Lush. Yields color, flavor and body at the instant of infusion. Smooth. | 1 35 | 2 50 |
| Kee-Mun. Chinese. An ideal breakfast Tea; most people like it any time. | 1 35 | 2 50 |
| Earl Grey. The Jacksons of London Earl Grey Tea. | 2 45 | 4 85 |
| Formosa Oolong. Semi-processed Tea; elegant bouquet, aroma and mild smooth flavor. | 1 35 | 2 50 |
| Lapsang Souchong. The smoky-flavored Tea that only China produces. | 2 15 | 3 95 |

TEA TASTER PACKAGE

Generous portion of each of the above eight kinds, enough in all to make 100 cups. \$1.50.

Other Unusual Teas

| | | |
|---|--------------|-----------------|
| Stumpp & Walter No. 5. Rare orange-pekoee buds from India; produces a full-bodied, fragrant, rich tea. | ½ lb. | Lb. |
| | \$1 15 | \$2 00 |
| Citrous-Scented Mixture. | 1 35 | 2 60 |
| Boston Mint Tea. Superior blend of orange-pekoee with a subtle flavor of mint. Box of 16 Tea-bags. | 3 for \$0 85 | Per doz. \$3 25 |

TEA TASTER TEA BAGS

(25 Bags in Tin Canister)

| | |
|-------------------------|-------------|
| Darjeeling | Each \$0 60 |
| Formosa Oolong | 65 |
| Kee Mun | 70 |
| Lapsang Souchong | 75 |
| Earl Grey | 85 |

TUXEDO COFFEE

Expertly blended rare selected Coffees. Grown on high land, where climate, soil and cultural methods produce a rich, full flavor. Used by America's first families for over a half century, and the choice of discriminating coffee drinkers everywhere. Regular or drip grind—please state which.

| | | |
|---|--------------|-----------------|
| Special. Now supplied in vacuum tins, to hold the aroma. 1 lb. tin | 3 for \$1 75 | Per doz. \$6 80 |
| Van Houten's Cocoa. The best for drinks or baking. ½ lb. tin | 1 20 | 4 65 |

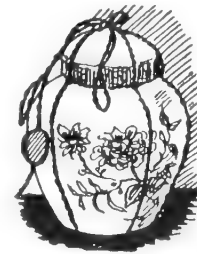

TEA CADDY

In colonial times, costly Tea was kept in a Tea Caddy. Stumpp & Walter Teas too deserve to be kept in one. Beautiful in design, made of china and holds 10 ozs. Filled with choice Tea. \$4.50.

TEA MASTER TEA POT

(TWO SPOUTS)

One side serves strong Tea; other side serves hot water for those who prefer a lighter brew. Your choice of colors—ivory, blue, maroon, turquoise; tell us which. Seven-cup capacity, \$4.00.



FOOD PACKAGES FOR SUMMER GIFTS

No. 1

\$5.00

- 1 Cocktail Franks
- 1 Pate de Foie with Truffles
- 1 Cheese Spread
- 1 Scotch Oat Cakes
- 1 Pineapple Vinegar
- 1 French Sherry Pralines
- 1 Fortune Teller Rice Cakes

No. 2

\$10.00

- 1 Colossal Ripe Olives
- 1 Anchovy Stuffed Olives
- 1 Crab Meat
- 1 Smoked Turkey Pate
- 1 Lobster a la Newburgh
- 1 Cashew Fruit Preserve
- 1 Carlsbaden Oblaten Wafers
- 1 Scotch Oat Cakes
- 1 Cocktail Cheese Spread

No. 3

\$15.00

- 1 Antipasto
- 1 Jumbo Shrimp
- 1 Tuna Fish
- 1 Truffled Goose Liver
- 1 Artichoke Bottoms
- 1 Whole Ox Tongue
- 1 French Sardine
- 1 Cocktail Cheese Spread
- 1 Fortune Teller Rice Cakes
- 1 Wallace Thin Mints
- 1 Brandied Peaches
- 1 Apricot-Pineapple Jam
- 1 ½ lbs. Weddle Tea
- 1 lb. Tuxedo Coffee
- 1 Della Robia Mints

Food Parcels are Thoughtful Gifts for Friends Abroad

American Food Parcels for All Parts of the World

PACKAGE No. 170

- 1 lb. Beef
- 1 lb. Bacon
- 1 lb. Vegetable Fat
- 1 lb. Rice
- 1 tin Evaporated Milk, 15 ozs.
- 1 lb. Tea or 1 lb. Coffee
- 2 tins Sardines, 8 ozs.
- 2 pkgs. Noodle Soup, 5 ozs.
- 4 ozs. Puddings
- 2 bars Soap

*To all Countries \$8 85

PACKAGE No. 171

- 3 lbs. Steak
- 2 lbs. Butter
- 2 lbs. Bacon
- 2 lbs. Coffee or 1/2 lb. Tea
- 1 tin Thick Cream, 10 ozs.
- 3 lbs. Flour
- 2 lbs. Sugar
- 2 pkgs. Noodle Soup, 5 ozs.
- 4 bars Soap, 1 lb.

*To all Countries \$16 95

PACKAGE No. 172

- 1 lb. Butter
- 1 lb. Rice
- 1 lb. Vegetable Shortening
- 2 lbs. Flour
- 1 lb. Sugar
- 1 lb. Jam
- 1/2 lb. Cheese
- 1/4 lb. Tea
- 2 bars Soap

*To all Countries \$8 40

PACKAGE No. 173

- 1 lb. Bacon
- 2 lbs. Butter
- 2 lbs. Vegetable Fat
- 1 tin Beef Steak & Onions, 15 ozs.
- 1 tin Sausage, 15 ozs.
- 1 tin Irish Stew, 15 ozs.
- 1 tin Chicken Dinner, 15 ozs.
- 1 lb. Rice
- 2 lbs. Flour
- 2 lbs. Sugar
- 1 lb. Tea or 2 lbs. Coffee
- 2 tins Evaporated Milk, 15 ozs. ea.

*To all Countries \$16 40

To England, Germany (All Zones), and all Countries in Europe. Average delivery 2 to 4 weeks.

*Because of Duty and Delivery conditions no orders will be accepted for Russia and Roumania until further notice.

Prices quoted include all charges and insurance, but do not include any fees or duties which may be imposed by local authorities.

Danish Food Parcels for all Parts of the World

PACKAGE No. 520

- 1 lb. 14 ozs. Lard
- 2 lbs. 3 ozs. Smoked Bacon
- 2 lbs. 3 ozs. Sugar
- 2 lbs. 3 ozs. Coffee
- 4 lbs. 6 ozs. Flour

*To all Countries \$10 50

PACKAGE No. 521

- 14 ozs. Dairy Butter
- 1 lb. 14 ozs. Stewed Steak
- 1 lb. 14 ozs. Ham & Bacon
- 12 ozs. Thick Cream
- 1.1 lbs. Cheese

*To all Countries \$9 75

PACKAGE No. 523

- 1 lb. 14 ozs. Stewed Steak
- 1 lb. 2 ozs. Cheese
- 14 ozs. Butter
- 1 lb. 14 ozs. Ham & Bacon
- 1 lb. Sugar
- 2 lbs. 3 ozs. Flour
- 8 ozs. Tea or 1 lb. Coffee
- 1.1 lbs. Honey
- 2 lbs. 3 ozs. Marmalade
- 12 ozs. Thick Cream

*To all Countries \$13 50

PACKAGE No. 525

- 1 lb. 12 ozs. Butter
- 2 lbs. Bacon
- 1 lb. 14 ozs. Ham & Bacon
- 1 lb. 14 ozs. Stewed Steak
- 12 ozs. Dairy Cream
- 1.1 lbs. Cheese
- 1.1 lbs. Sugar
- 1.1 lbs. Strawberry Jam
- 1.1 lbs. Honey
- 1.1 lbs. Chocolate

*To all Countries \$15 50

ALL PARCELS LISTED ON THIS PAGE FULLY INSURED

For more complete collections send for our Special Overseas folder.



Gift Food Parcels for the British Isles

FASTEST DELIVERY

Orders are AIRMAILED to LONDON and shipment made within 24 hours.

FINEST QUALITY

These parcels are packed and shipped by THE WORLD FAMOUS

J. LYONS & CO., Ltd.
Cadby Hall, London, England

Purveyors to the Royal Family

PACKAGE MB

- 1/4 lb. Lyons Tea
- 2 lbs. Lyons Rich Dundee Fruit Cake
- 1/2 lb. Margarine
- 5 ozs. Dried Whole Eggs
- 2 lbs. Sugar
- 1/2 lb. Lyons Sponge Cake
- 1/4 lb. Lyons Chocolate
- 1/4 lb. Hard Candy

Price Complete \$6 00

PACKAGE MC

- 1/4 lb. Lyons Tea
- 1/2 lb. Margarine
- 2 lbs. Lyons Rich Dundee Fruit Cake
- 1 lb. Brisket of Beef
- 1 lb. Veal, Ham & Tongue Gelatine
- 3/4 lb. Tongue
- 3 ozs. Meat Spread
- 3 lbs. Fish Spread
- 2 lbs. Sugar
- 5 ozs. Dried Whole Eggs
- 3/4 lb. Swiss Jelly Roll
- 1 lb. Lyons Chocolate Crispy Fingers
- 1 lb. Custard Powder
- 1/4 lb. Lyons Chocolate
- 5 ozs. Jelly

Price Complete \$10 50

PACKAGE C

2 lbs. Lyons Rich Dundee Fruit Cake (Packed in a tastefully decorated strong tin)

Price Complete \$2 25

PACKAGE MF

- 1 lb. Chocolate Peppermint Creams
 - 1 lb. Crispy Fingers
 - 1/2 lb. Hard Candy Fruit Drops
 - 1/2 lb. English Bullseyes Hard Candy
 - 1/2 lb. Nutty-Nibs Candy
 - 1/2 lb. Lyons Chocolate
 - 4 bars Milk Chocolate
 - 4 bars "Slam" Chocolate Biscuits
- Net 5 lbs.

Price Complete \$4 80

Prices shown include packing and postage to any address in the United Kingdom of Great Britain and Northern Ireland.

Baskets

- General-Purpose Basket**
 1-bus. size.....\$3 00
 2-bus. size..... 4 00
 3-bus. size..... 5 50
- Gardeners' Baskets**
 20 x 11 x 6½ in. deep.. 3 50
 24 x 15 x 8½ in. deep.. 4 00
- Picking Basket**
 ¼-bus. size..... 2 25
 ½-bus. size..... 2 75
- Flower and Fruit Baskets**
 13 x 13 x 3½ in. deep.. 2 00
 24 x 12 x 3½ in. deep.. 2 50



Window-Boxes

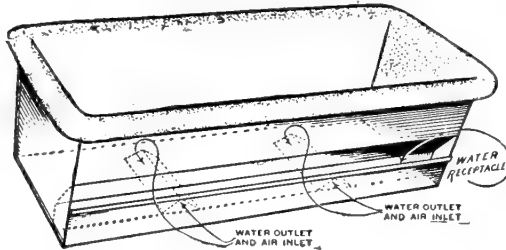

- Made of galvanized sheet metal. Painted green. Each
- | | |
|--------------------------|--------|
| 24 x 7 x 6 in. deep..... | \$3 75 |
| 30 x 7 x 6 in. deep..... | 4 50 |
| 36 x 7 x 6 in. deep..... | 5 50 |
| 42 x 7 x 6 in. deep..... | 6 50 |
| 48 x 7 x 6 in. deep..... | 7 50 |

Handi-Cart. Sheet-metal body; disc wheels; rubber tires. For a thousand odd jobs. Tip down to load. Capacity, 3 cu. ft. Length, 26½ in.; width, 19 in.; depth, 14 in. \$7.50.



Sawco Magnesium Lawn Barrow



The new, light-weight, sturdily built, perfectly balanced, easy to move Barrow. Weighs only 14 lbs., made of magnesium. Barrow measures 26½ in. x 32 in.; overall length 50 in. Painted French gray, under-structure bright blue, 1½ in. diameter extruded magnesium tubing handles. Rubber tire 2.75 x 10, on roller bearings. Amazingly light and easy to handle. \$29.95.

Bready Garden Tractor

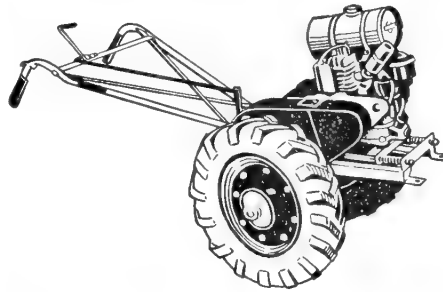

A powerful 1½-horsepower garden Tractor plus exclusive front hitch, giving twice as much work as others in its class. All Bready attachments are hitched to the Tractor forward of the axle. Uses only one gallon gas in five hours. Can be used all year round, doing all the hard jobs quickly and easily. Ratchet wheels for easy turning. Equipped 5.00 x 12 pneumatic tires, \$225.00. Prices on other attachments as follows:

- | | |
|--|---------|
| Plow with Coultter | \$27 00 |
| Disk Harrows (two four-disc gangs).. | 33 75 |
| Spike-Tooth Harrow | 23 00 |
| Front or Rear Cultivator | 30 50 |
| Snow Plow . 42 in. wide..... | 50 00 |
| Cutter Bar . 32 in. wide..... | 80 00 |
| Lawn Mower . 21 in. width (heavy-duty unit)..... | 75 00 |
| Lawn Roller, Water Ballast, with seat . 19 in. diam., 30 in. long.... | 52 00 |
| Dump Cart . ¼ ton, pneu. tires.... | 89 00 |

Rotary Tiller



Rebuilds soil nature's way, cuts and mulches vegetation throughout tilled depth, prepares a perfect seed bed and increases crop yield. Prevents erosion, produces earlier disintegration, increases mineral and moisture content, requires less commercial fertilizer. Tines are rugged forgings designed so that average stones pass through and lift over larger ones. Tills a 16-in. swath from air-cooled engine. 5 horsepower for light and sandy loam, \$445. 7 horsepower Model for stony and rough land, \$475.

Warren-Church Cedar Fence

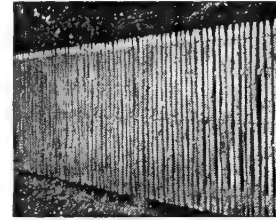

Made of split cedar poles spaced ¾ inch apart. Furnished in rolls 16 ft. long. Gates to match.

| Per lineal ft. | With Posts and Rails 3½ ft. wide per lineal ft. Walk-Gates | |
|---------------------|--|----------------|
| | Per lineal ft. | Per lineal ft. |
| 3 ft. high...\$0 90 | \$1 20 | \$9 75 |
| 4 ft. high... 1 20 | 1 35 | 11 50 |
| 5 ft. high... 1 10 | 1 60 | 13 50 |
| 6 ft. high... 1 45 | 1 85 | 15 00 |

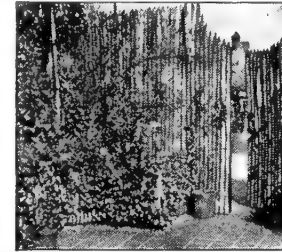

Sawco Woven Wood Fence

Made of split White Cedar. Comes in sections 5 feet long and four heights. Gates to match.

| Sawco Woven Wood Fence in a city penthouse garden | Plain With Posts 3½-ft. Per and Rails wide lineal Per lineal Walk-ft. Gates | |
|---|---|----------------|
| | Per lineal ft. | Per lineal ft. |
| 3 ft. high..... | \$1 75 | \$2 00 \$15 00 |
| 4 ft. high..... | 2 15 | 2 45 17 50 |
| 5 ft. high..... | 2 35 | 2 65 18 00 |
| 6 ft. 6 in..... | 2 75 | 3 15 20 00 |

Customer pays transportation on all above Fences and Gates

Sawco Watering Pot.

Round Watering Can made of 26 gauge galvanized steel, reinforced bottom. Heavy copper tube, ¾-in. handle. With two roses, fine and coarse. Capacity, 12 qts. \$13.50 each. Extra Roses \$1.50 each.

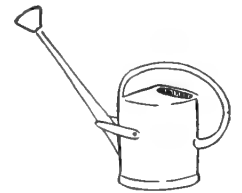

Warren-Church Watering Pot.

Made of heavy galvanized iron. Short spout. Rose attached firmly with screw joint, cap removable for cleaning. 6-qt., \$1.75; 8-qt., \$2.25; 10-qt., \$2.75.



Lawn Prong

Made of steel; 3 sharp prongs 9 in. long, socket 8 in. long, 1½ inch diam. with set screw for additional strength. Inserts into your lawn with body weight. Holds fast in the strongest winds. Ideal for lawn and beach umbrellas, badminton and tennis nets, portable lawn shower, to display the American flag, outdoor Christmas tree, lawn lights for parties and many other uses. Easily removable and set from place to place. \$3.98. Larger diameter sockets priced on request.

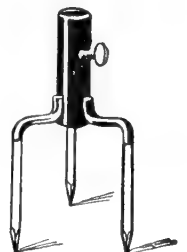

IMPROVE YOUR LAWN

with an occasional dose of LAWNSPREAD. May be used at any time of the year. Unit of 25 pounds treats 200 to 400 square feet and costs \$3.



STIKIT WIKIT not only affords lasting protection but beautifies your lawn, garden and flower beds. Made of $\frac{3}{8}$ -in. hardened steel, enameled green, STIKIT WIKIT comes in convenient cartons of 2 doz., enough for an attractive 24-ft. fence. Individual Wickets 12 in. wide, 20 $\frac{1}{2}$ in. high, \$5.25 per carton delivered.

"Beat All" Wall Nail

For training vines, ramblers, etc. Made of metal with pliable lead tip which can be bent to any desired position. 1 $\frac{1}{2}$ in. long. 75 cts. per doz., \$5 per 100.

Sawco Garden Gloves



Velvety smooth ivory white leather with gauntlet. Ideal for gardening, motoring, and household tasks. Sizes 6, 7, and 8. \$2 per pair.

Horsehide Gloves. Very strong for heavy garden work and pruning. Sizes 10 and 11. \$2.50 per pair.

Featherlite Tool Set

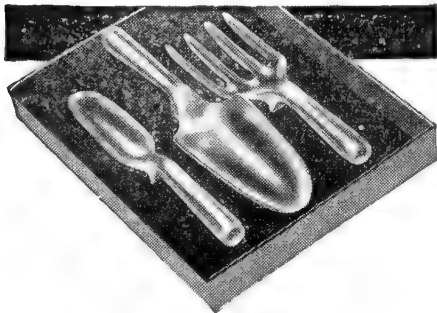

Made of high quality aluminum alloy; super strength; featherlite; perfect balance. Special finger rest prevents slipping; eliminates fatigue. Set consists of one regulation trowel, 5 $\frac{1}{2}$ -in. blade, 3 in. wide; one transplanting trowel, 4 $\frac{1}{2}$ -in. blade, 1 $\frac{1}{2}$ in. wide; and one cultivating fork, 4-tine, 4 $\frac{1}{2}$ -in. prongs, 3 in. wide. An ideal gift for your gardening friends. \$3.95 per set. Tools may be purchased separately at \$1.50 each.



Noxweed Cane. Made of brass tube. Holds about 6 ozs. of fluid ejected by drops from point; destroys Dandelions, Plantains, and many other weeds. No stooping, no digging, no holes in the lawn. Complete with 1 qt. Liquid, \$2.50. Extra Liquid, 85 cts. per qt.

Eastern Garden Pump

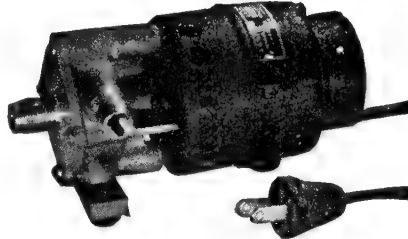

A compact handy electric motor unit for fish-ponds, lily-ponds, and other small bodies of water. Specially constructed with intake and outlet for pumping the same water over and over again. \$45.

FORKS



Spading Fork

Spading Forks. Best grade; tines spear-pointed with diamond-shaped back; handle strapped both sides. Each

4-tine, D-Handle.....\$3 00

Plant Stakes, Wood

| Plant Stakes, Green. Light, square. | Doz. | 100 |
|-------------------------------------|--------|--------|
| 3-ft. x $\frac{3}{8}$ in..... | \$0 75 | \$5 00 |
| 4-ft. x $\frac{3}{8}$ in..... | 95 | 7 00 |
| 5-ft. x $\frac{3}{8}$ in..... | 1 80 | 13 50 |

| Plant Stakes, Green. Heavy, Square. | Doz. | 100 |
|-------------------------------------|--------|---------|
| 4 ft. x $\frac{7}{8}$ in..... | \$1 75 | \$12 00 |
| 5 ft. x $\frac{7}{8}$ in..... | 2 25 | 17 50 |
| 6 ft. x $\frac{7}{8}$ in..... | 2 75 | 20 00 |
| 7 ft. x 1 in..... | 3 50 | 25 00 |

Bean Poles (with bark on). 8 feet long; 2 to 2 $\frac{1}{2}$ -inch butt. Also ideal for supporting blackberries, raspberries, boysenberries, etc. 35 cts. each, \$3.50 per doz. Customer pays transportation.

Adjusto Plant Supports

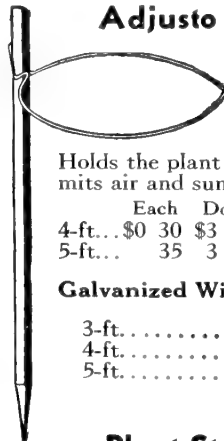

Sturdy hard wood stakes, $\frac{7}{8}$ -inch square, with a strong wire support instantly adjustable to any height.

Holds the plant firmly together, yet admits air and sunlight.

| Each | Doz. | Each | Doz. |
|---------------|--------|---------------|--------|
| 4-ft...\$0 30 | \$3 00 | 6-ft...\$0 40 | \$4 00 |
| 5-ft... 35 | 3 50 | | |

| Galvanized Wire Stakes. | Doz. | 100 | 1000 |
|-------------------------|--------|--------|---------|
| 3-ft..... | \$0 40 | \$2 50 | \$18 75 |
| 4-ft..... | 50 | 3 30 | 24 75 |
| 5-ft..... | 60 | 4 00 | 30 00 |

Plant Stakes, Cane

American Bamboo, Dyed Green. For staking gladiolus, annual flowers, etc., in the garden. Uniform pencil thickness.

| | 100 | 1000 | | 100 | 1000 |
|---------------|--------|---------------|---------|-----|------|
| 2-ft...\$1 25 | \$9 00 | 4-ft...\$2 25 | \$16 50 | | |
| 3-ft... 1 75 | 12 50 | 5-ft... 2 75 | 19 50 | | |

HOES

Victory Cultivator Hoe



Victory Cultivator Hoe. Destroys weeds; leaves the soil loose. Long handle, 3-prong, \$1.25; 5-prong, \$1.50.

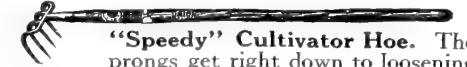

"Speedy" Cultivator Hoe. The prongs get right down to loosening soil. Ideal weeder. 3-prong, \$1.50; 4-prong, \$1.75.



Magic Cultivator. Made of round galvanized steel. Handy tool for the home-garden. 3-tine, short handle, 25 cts.; 3-tine, 36-in. handle, 45 cts.; 4-tine, 42-in. handle, 75 cts.

Warren or Heart-shaped Hoe

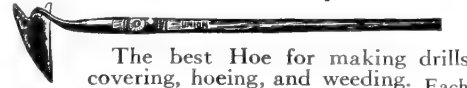

The best Hoe for making drills, covering, hoeing, and weeding. Each 4-ft. Handle, 7-in. blade.....\$1 75
Midget, Short Handle, 4 $\frac{1}{2}$ -in. blade.. 85

Handy Hoe

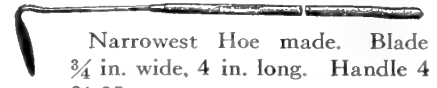

Narrowest Hoe made. Blade is $\frac{3}{4}$ in. wide, 4 in. long. Handle 4 ft. \$1.25.



Shrub Protector. A wire guard with sharp points, easily fastened around shrubs to keep dogs away. Practical and economical. 30 cts. each, \$3 per doz.

Come-Along Hand Power Unit

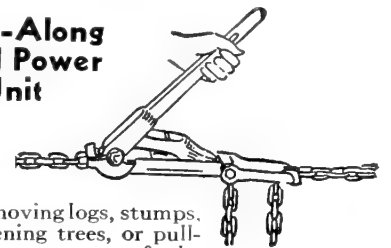

For removing logs, stumps, straightening trees, or pulling your car out of the ditch. Equipped with 5 feet of $\frac{3}{8}$ -inch strong chain. Tested to 6000 pounds. Length of travel 47 inches. Weight 18 pounds. \$14.50.

Bird Netting

For the protection of strawberry beds and fruit trees against birds. 1-in. mesh only, 30 ft. wide. Cut to any length desired \$4 per 100 sq. ft.

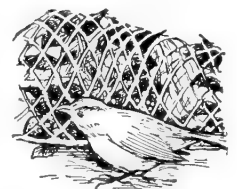

WHEN YOU STAKE YOUR TOMATOES, fasten them with

PLANT-TWISTS,

made of wire which bends easily; plant is protected by soft fibers.

50 cts. per 100

HOSE Greenlawn



Rubber. A heavy-duty two-braid corrugated green Hose of high quality. $\frac{3}{4}$ -inch, 50-ft. length \$16.50, 100 ft. \$30.

WAYAHEAD

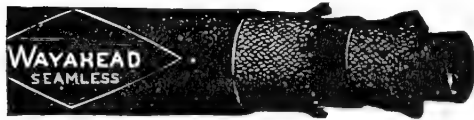

Rubber. Special heavy duty. Surpasses all the cheaper grades of Hose. A two-braid Hose with a smooth black cover. $\frac{3}{4}$ -in. bore, 25 ft. \$8, 50 ft. \$15, 100 ft. \$28.

SUPPLEX PLASTIC HOSE

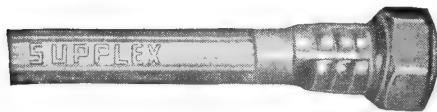

A superior plastic hose, aluminum color, $\frac{1}{2}$ -in. bore, that is mildew-proof, sun-proof and will withstand freezing temperature. Smooth performance eliminates friction loss. $\frac{3}{4}$ -in. fittings. 25 ft. \$4.75, 50 ft. \$7.95.

Flaring Rose Hose Nozzle

Ejects a fan-like gentle spray. For watering seedlings and newly planted grass-plots. Stamped brass, \$1 each.



Justrite. Gives a copious spray or full stream. Made of brass. 90 cts.



Hosnap Coupler

Made of brass. One end fastens to the faucet, the other end to the hose. Can also be used for connecting two pieces of hose. Push-in and pull-out feature eliminates awkward screw-on method of attaching hose. Has a swivel action to eliminate twisting. \$1.35.

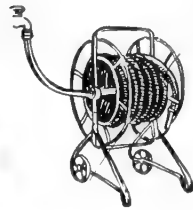

Salem Real-Reel. Finest Hose Reel made. Holds up to 150 ft. of $\frac{3}{4}$ -in. hose. Connect the 5-ft. accessory hose to faucet, and water passes through hose as it reels off. All metal. Complete with 5-ft. accessory hose only, \$12.50.



Steel Tool Holder. For hanging tools in your garage or barn. Extends 13 in. out, 3 in. wide. Notched for five tools. 90 cts.

Spike Tamp. An indestructible, combined Perforator and Tamper made of malleable iron. Can be quickly converted from Spiker to Tamper by loosening one nut. Plate 9 in. square. Spikes $1\frac{3}{4}$ in. long, tapering. Overall length 4 ft. Weight 13 lbs. \$5.75.

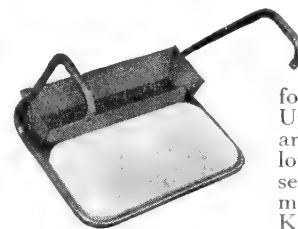
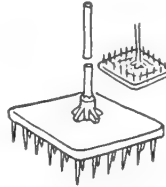

Gardenade. Kneeling pad and a convenient rack for garden tools. Upright handles are designed to lower and lift yourself with a minimum of effort. Kneeling pad is

made of soft sponge rubber. 14 in. long, 11 in. wide, 12 in. high. Tool box holds all the tools within your reach. Has many household advantages, such as cleaning floors, waxing and polishing. \$3.50.

Kumfort Knee Pads.

A comforting knee-cushion with adjustable straps. Fits any knee; will not slip down when walking. Prevents moisture from penetrating the clothes and provides added life to work clothes. \$2 per pair.

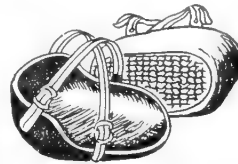

Turf Edger

Half-Moon Edging Knife. Solid steel, with a polished handle \$1.75.

Crab Grass Eliminator Rake

Fits any mowers from 15 to 19 inches wide. Lifts the crab grass and seed spikes from the ground so the mower can slice them off. Attaches very easily to mower, \$2.

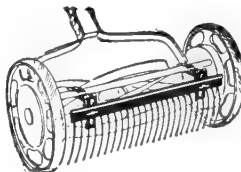

Scythe Blades. Cutlery steel, natural oil finish; cutting edge, web and backs polished. 28 to 32 in. \$3 50



Bush Scythe Blade. Heavier and shorter than a grass Scythe; 18 in. long. For heavy growth where ordinary Scythe is impractical. Blade only, \$3.

Scythe Snath or Handle. The very best, with patent socket. \$3.50.

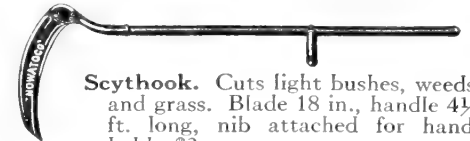

Scythehook. Cuts light bushes, weeds, and grass. Blade 18 in., handle $4\frac{1}{2}$ ft. long, nib attached for hand-hold. \$3.

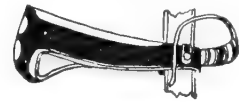

Brush Knife. For cutting in wooded terrain. $16\frac{1}{2}$ in. overall. Blade 12 in. Special pigskin

safety-type grip. Complete with metal sheath. \$4.50.

Earle Special Bush Hook. Ideal for heavy work. \$4.

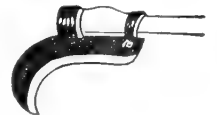

Scythe Stones



Scythe Stones, Genuine English. Round, tapering. 60 cts.

Sawco. 35 cts. each, \$3.50 per doz.



Flower Gathering Shears. Nickel-plated. Made to hold within its grasp stems of cut-flower. \$2.50.

Hubbard Flower Cutter and Pruner

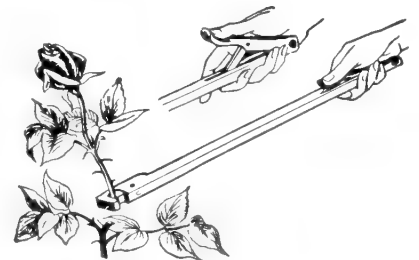

It cuts. It holds. It reaches. All aluminum. Weighs only 5 ozs., is 18 in. long. Ideal for the rose garden and arbor for cutting blooms and getting out of the way of thorns. Cutting knife made of special tool steel. Operated by easy thumb-action lever. \$3.50.

Great American Lawn Mower

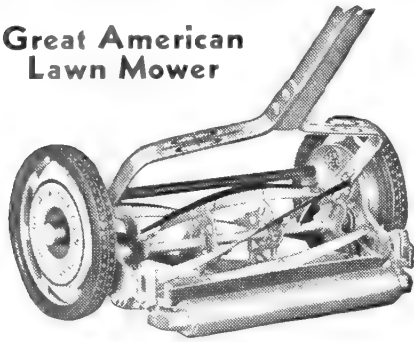

Reliable heavy-duty machine. Height of mown turf can be regulated from 1/2 to 1 1/2 inches; will cut grass 6 inches high. Wheels are 10 inches high. Hard rubber tires.

| | Price 5 blades | Grass Catcher |
|-------------|-------------------|------------------|
| 17-in. | \$27 50 | \$2 50 |
| 19-in. | 30 00 | 3 50 |

Clemson Precision Lawn Mower

An exceptionally fine Mower before the war and still continuing leadership in engineering refinements. Easier rolling, easier turning, no "bobbing" on bumpy ground. More rigid—stays in alignment. Worm-gear action for micrometer-like self-locking adjustments without tools. Cuts closer to front and side obstructions. Finger-grooved plastic handles with bracket to hold clipper. 17-in. cut. Hard rubber tires. \$29.95. Grass Catcher \$2.50.



Weedmaster

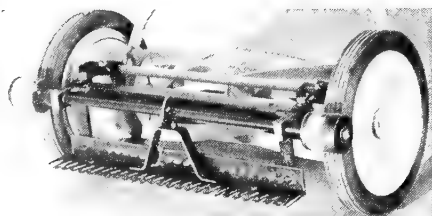

Attaches to most lawn mowers. Simply hook over your tie rod. Adjust with set screws on attaching hooks. Self-sharpening; will last for years. Ideal for cutting down niggerheads, plantains and dandelions, which your regular mower cannot do. 16 to 17-in. or 18 to 19-in. mowers (state size) \$5.95.

Warren - Church Grass Shears. Up-and-down action handle with 5-in. blades. \$2.50.



Grass Shears. Standard design. High-quality tool steel. 6 1/2-in., \$2.50.



Sawco Long-Handle Trimming Shears. Operated from top of handle by connecting rod. Length of cutting blades 6 3/4 in., ht. of Shears 38 in. Nostopping. \$3.75.

Border Shears. To trim overhanging grass on borders, flower-beds, and walks. 9-in. blades of high-grade tool steel, polished handles and blades. Without wheel \$7.50. Wheel model not available.

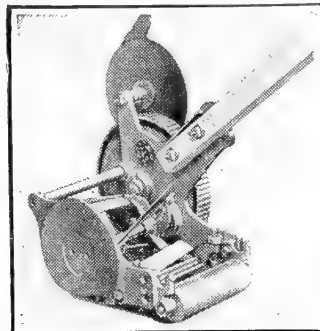

Lawn Trimmer and Edger. Equipped with steel disc and small plow. Width of cut, 6 inches. Mows close to trees, walls, paths, and flower beds. \$19.95.

Springfield Lawn Sweeper

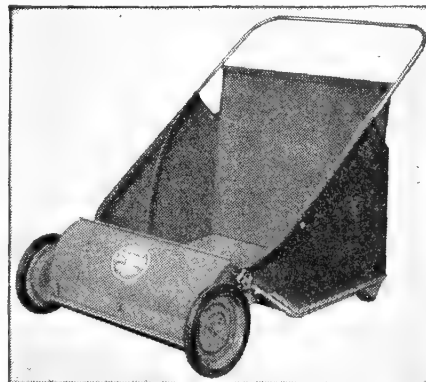

Operates with easy, whirling movement that lifts leaves, cut grass, sticks, stones or paper. Controls spreading of obnoxious weeds by collecting the seed. Makes a beautiful lawn. Precision built of cast aluminum alloy, non-rusting. Five brushes of heavy fibre securely fastened to ball-bearing reel assure economical upkeep and easy replacement. Brush adjustable for heavy or light sweeping of variable-height grass. Heavy canvas, metal-bottomed, collecting hopper, 5-bushel capacity, collapsible for easy storage. Senior model, 28 in. sweeping width, \$48.50. Junior model, 20 in. sweeping width, \$37.50.

Hedge Shears

Sawco Domestic. Well made and of excellent quality. 9-in. blade. With notch. \$3.75. 6-in. blade. Plain. Ladies'. \$2.75.



Warren-Church. Lightweight: under 3 lbs. Magnesium handles, rubber grips. 8-in. blade. Notched. \$5.50.

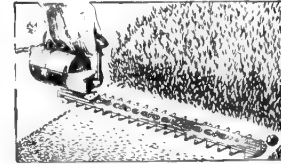

Syracuse Electric Hedge-shear. Cuts hedges, shrubbery, and grass. Cutters self-sharpening, revolving on endless chain. Cuts on both sides of cutter-bar. Electric motor. 6 lbs. With 10-ft. Cord, \$39.95. Extra 100-ft. weather-proof Cord, \$8.50. (Early August delivery).



Sunbeam Hedge Trimmer. Sensational new electric Trimmer for hedges, shrubs, and ornamental trees. 12-in. cutlery steel blade, well balanced. Weighs 4 1/4 lbs. 110 V AC-DC motor fitted into the handle. On-and-off switch within easy reach. Precision made. With 10 ft. of cord. \$37.50. Extra weatherproof rubber cord, \$8.50 per 100-ft. length.

Rotary Hedge Trimmer

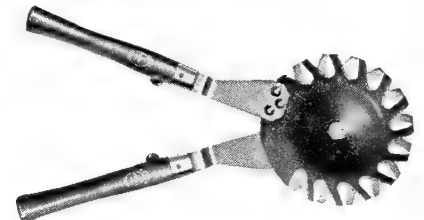

A new fast-type rotary Hedge Trimmer. Now the hedge takes the trimming, not you! A rotary blade cuts in all directions at once. Cuts work, cuts time, cuts hedge. Weighs only 1 lb. 15 ozs. \$6.95.

Steel Brume Rake. With polished wooden handle. Cleans the turf as gently as one's hand. 19 in. wide. \$1.75.

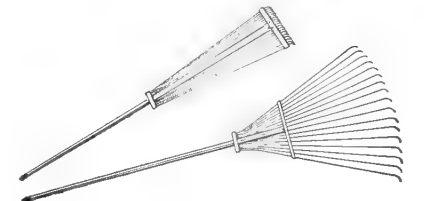
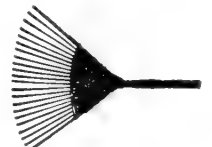

Aluminum Adjustable Rake. No need for several Rakes. This 4-in-one is ideal for grass, leaves, soil and gravel. Weighs only 24 ozs. Will not rust. 48 in. long. Instantly adjustable. Spread from 10 to 30 in. Tines slightly flattened on end. \$5.

Use **Plant-Foods** generously for best results in your garden.

Sawco General Garden Fertilizer

will work wonders; use 25 pounds or more per 1000 square feet. 100 lbs. \$6.

Dayton Lawn Sprinkler

Designed for low and moderate water pressure. Adjustable while in operation for rotary spread and from a light spray to a heavy stream by means of a thumb screw. Sled-type base enables you to pull it over the lawn without tearing up the turf. Covers up to 75 feet in diameter with 40 pounds pressure. \$8.

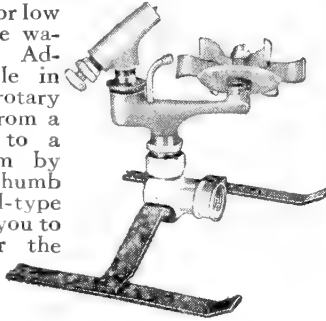

Dayton 3-Way Sprinkler

Three different sprinkling heads combined in one unit. Easy to operate, changing from one to another position instantaneously; no tool needed. Can be regulated to spread from a few feet up to 28 feet. Half-spray adjustment ideal for narrow spaces, curbed strips, etc. \$6.50.



Skinner Roto Sprinklers

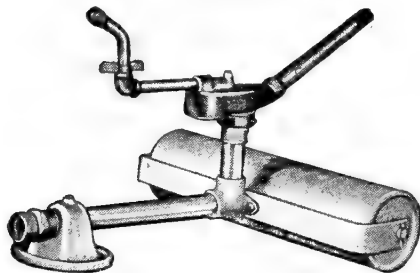

Junior. On 20 to 60 lbs. pressure. Covers 60 to 100 ft. diameter. \$15.75.

Senior. On 35 to 70 lbs. pressure. Covers 95 to 140 ft. diameter. \$18.75.



Mist-Master Sprinkler. Made of zinc alloy; rust-proof. Weighs 1½ lbs. Delivers a fine spray 30 ft. in diameter. 98 cts.

With this device you can water your plants at their roots and can give them plant-food at the same time. The ½-inch diameter, 36-inch tube has three discharge openings 6 inches from point. Equipped with shutoff to control flow of water and a cartridge chamber for feeding, with twelve Cartridges. \$4.98. Plant Food Cartridges, \$1 per doz. extra.



Ross Root Feeder

Spray Wave



An oscillating fan of spray covering 50 x 40 feet, with an adjustable length of travel and variable speed. Complete on skid, ¾-in. hose connection. \$22.50.

Crescent Sprinkler

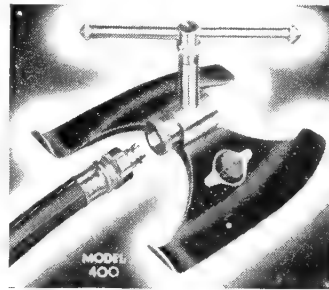

Adjustable head provides low and high spray. Gives excellent performance and water coverage. Furnished with a brass Hosnap Coupler for easily disengaging Sprinkler for nozzle use and vice versa. \$4.45.

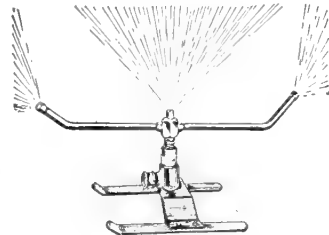

Triple Shower Sprinkler. The best Sprinkler made in its price-range. Operates on 15 lbs. of pressure. Covers a large area uniformly and properly. \$3.50.

Water Wand



Releases water in a steady, yet gentle flow at base of plants. Provides maximum amount of water with minimum waste. Water is left motionless to sink deep into the soil. Connects to your garden hose. Long handle permits watering flower-beds without stepping on soil or trampling flowers. Overall

length 52 inches. All parts cadmium plated to resist rust. \$3.

Soil Soaker Hose

Now you may use the same successful deep-soaking method employed by big commercial irrigators. Made of porous canvas, 2 inches in diameter. Water seeps through pores; no spray. Equipped with regular hose connection for attaching to hose or pipe. 18 ft., \$2.25; 30 ft., \$3.25; 50 ft., \$5.25.

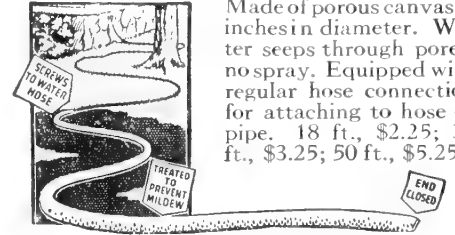

Ring Lawn Sprinkler



Made of heavy gauge sheet brass; 8½ inches in diameter; ¾-inch connection. Throws a well-distributed spray. \$1.50.

Trowels



Stumpwall. Best Trowel made. The ferrule and shank, as well as the blade, are forged in one piece; 6 inches long. \$1.50.

Forged Steel. This Trowel is second to the Stumpwall Trowel in quality and finish. The blade and shank are one piece, forged out of the best steel. 6-in., \$1.

Twines, Tape and Raffia

Silkaline. F, fine; FF, medium; and FFF, coarse. Spool 40 cts., box of 8 spools \$3.

Binder Twine. Approximately 8-lb. balls \$4.50.

Bouquet Twine. White. 2¾-oz. ball 20 cts., lb. \$1, 5 lbs. \$4.75.

Twine, Soft Jute. For tying vines, etc., without danger of bruising. Very strong; 3-ply. **Natural.** ½-lb. ball 40 cts., 3 balls \$1.10, 12 balls \$3.50. **Green.** ½-lb. ball 50 cts., 3 balls \$1.40, 12 balls \$5.

Tarred Yarn. Excellent, low-priced material for raspberries, shrubs, etc. Ball (1 lb.) 85 cts., 5 balls \$4.

Raffia, Natural. For tying plants, ½lb. 50 cts., lb. 90 cts., 5 lbs. \$4.

Dyed Green. ½lb. 90 cts., lb. \$1.75.



Plant-Twists. Dyed green. Non-injurious to plants. A simple twist of the hand and the plant will stand. 7 inches long, 15 cts. for 25; 50 cts. per 100. 12 inches long, 30 cts. for 25; \$1 per 100.

Twistems. 8-in. Pkg. of 125, 35 cts.

Sprayers and Syringes

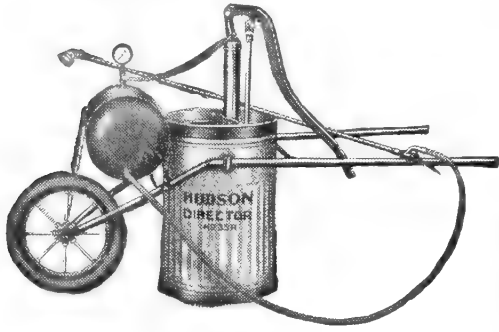

Warren-Church Wheelbarrow Sprayer. Portable outfit for shrubbery, small orchards, whitewash or disinfectants. Galvanized tank; pump has agitator. Steel frame; wheel has semi-pneumatic tire. Develops 150 lbs. pressure. With 6 ft. of $\frac{3}{8}$ -in. pressure hose, automatic shutoff, trigger lock, 2-ft. extension rod, and angle nozzle. Hand operated. 12 gals., \$39; 18 gals., \$47.50.



Sawco Tank Sprayer. A superior galvanized Sprayer for use around the home, garden, stable or poultry-house. Open top, 4-gal. capacity; threaded fittings; precision made. Reinforced steel ring welded at bottom. With 5 ft. of hose, 24-in. extension rod, automatic shutoff, which can be locked, angle fog-nozzle.

Has new type leather cup washer; also new type valve. Finest Sprayer made. \$12.95.

Sawco Stainless Steel Sprayer. (Not illustrated.) Similar to the above, but made of Stainless Steel. A superior tank Sprayer that should last a lifetime. Handles corrosive formulas of oil and acid-base insecticides. Open top for easy filling and cleaning. Furnished with 2 feet of spray hose, automatic shutoff valve, 24-in. extension rod, angle spray nozzle and adjustable carrying strap. \$19.50.

Sawco Copper Tank Sprayer. (Not illustrated.) Open top; 4-gal. capacity; with 2 ft. of spray hose; automatic shutoff valve, 24-in. extension rod and angle spray nozzle. \$16.95.

Sawco Compressed-Air Sprayer

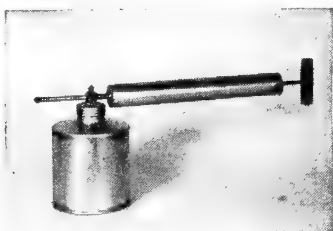

The most perfect small hand Compressed-Air Sprayer made. Delivers a **continuous** fog-like spray. Is fitted with straight and adjustable nozzles making a perfect **under-leaf Sprayer**. Holds 1 qt. Sturdy construction. Wonderful performance.

Brass Pump and Copper Tank.....\$3 00
All Tin..... 1 75
Tin Pump, Brass Fittings, Glass Tank
(Not illustrated)..... 2 00

Sawco Knapsack Sprayer



A high-pressure Knapsack Sprayer that gives 100-pound pressure in seven strokes. Can be pumped with either left or right hand. Self-oiling ball-and-socket fulcrum developing high, continuous pressure. Easily cleaned and drained. Leakproof hinged cover. Tank 4 gallons capacity. Equipped with 3 feet of $\frac{3}{8}$ -inch hose, 24-inch extension rod, and automatic shutoff with trigger-quick spray-lock, any angle nozzle. Paddle Agitator. Galvanized \$24.95. Copper \$32.95.



Master Bucket Sprayer. A slide- or trombone-type Sprayer that operates from a bucket. For vegetables, flowers and plants. Spray nozzle adjustable from fine mist to coarse spray. Precision-made of brass. \$8.50.

No Weeds No Work New HUDSON 2, 4-D Sprayer

Now you can get rid of weeds by simply walking over your lawn. Just fill this Hudson Sprayer with 2, 4-D and push it over the grass. You spray a 2-foot swath evenly, without waste. It's safe—designed expressly for 2, 4-D. It's clean—no muss, no fuss.

Corrosion-proof lifetime copper tank.

Easy-working pump.

Oil- and chemical-proof hose.

Light and rugged aluminum cart, rubber-tired wheels. \$19.95 Complete.

Dust Respirator

Approved by the Bureau of Mines for use in conjunction with all types of dusts and sprays including Arsenate of Lead. \$3.

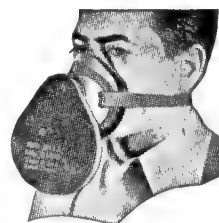

Sawco Flame Gun

For burning weeds, disinfecting poultry houses, thawing frozen pipes, melting ice and snow, splitting large rocks and boulders, burning tree stumps, sterilizing soil, destroying weeds, pests and grasshoppers, locusts, caterpillars, chinch-bugs, etc. \$22.75.

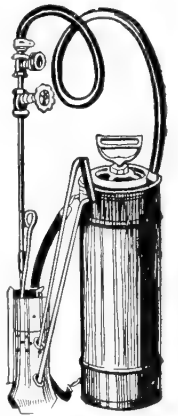

Woodason's Bellows



For dusting plants with dry powders. **Single Cone.** Small size \$5; large size \$6.50



Sawco Dust Gun. For Hortex, Tobacco, D.D.T., Hellebore, Paris Green, Lead Arsenate, Sulphur. Capacity 12 ozs. \$1.75.

Warren-Church Incinerator

Fabricated of high-quality steel $\frac{1}{8}$ in. thick. Seams are securely welded. Will outlast many ordinary Incinerators. Height 32 in.; diam. 18 in. Raised bottom. \$6.50.



Havahart Animal Trap

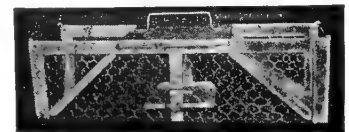

Made of steel and screened wire. Very easy to set. Harmless to animals and humans. 7 x 7 x 24 in. (for Muskrats, Mink, Rats, Chipmunks, Weasels, Squirrels, Rabbits), \$4. 11 x 11 x 36 in. (for Woodchuck, Raccoon, Opossum, Cats), \$8.75.

Special Fox Trap with live bait compartment. \$13.50.

Japanese Beetle Trap

Type 4. Most recent Trap developed. Especially suitable for large homes and estates. Rust-resisting, galvanized steel, enameled green and white. Complete with can of bait (no jar) \$1.85. Extra can of bait 75 cts. Steel rod for hanging. 75 cts.



Use The HUBBARD Pruner and Flower Holder To Cut Your Blooms. \$3.50

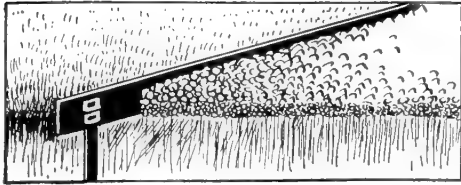

Estate Curbing

For neatness in your roadways and garden paths, it is unsurpassable. It adds richness to your home and surroundings. Made of natural steel 5 in. wide by 1/4 in. thick, with 18-in. steel stakes fabricated into the steel. Comes in 20-ft. lengths. Up to 100 ft., 90 cts. per ft.; 100 to 200 ft., 80 cts. per ft.; 200 to 500 ft., 70 cts. per ft., f.o.b. factory (customer pays transportation).

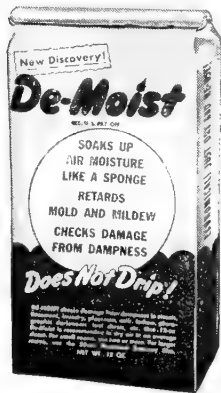

De-Moist

New discovery. Retards mold and mildew. Soaks up air moisture like a sponge. Checks damage from dampness. Does not drip. Can be used over and over again. Hangs up anywhere. 12-oz. size for closets, small rooms, food bins, trunks, etc. \$1.29. 50-oz. size for basements, large rooms, attics and laundries, \$4.95.

Coronet Flower Arrangers



Made of solid copper with copper-riveted lead base. Can be bent or shaped to fit any receptacle. Each holder fitted with double row of spiral copper sheet holes, adjustable for any angle. One of the finest Flower Arrangers ever made. No. 1. 1/4-in. holes \$1.25. No. 2. 3/8-in. holes \$1.75.

Flower Holder Set No. 3221

Guaranteed never to tip; made of non-corrosive metal. Contains 2 Pin-Type holders 1 1/2 in. and 2 1/4 in. in diameter and 1 Dome-Type holder 3 1/2 in. in diameter. Attractively displayed in gift box. \$1.75.

Sawco Weathervanes

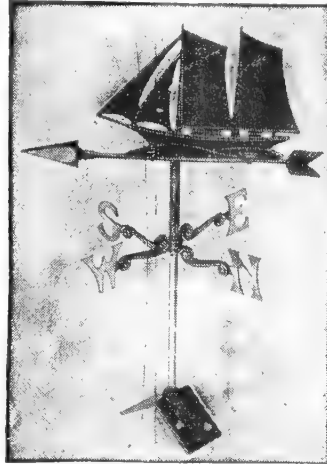

Made of non-corrosive cast bronze with cast aluminum, full relief figures. Finished in shadow black, bright brass upright, polished bronze letters. All Vanes are perfectly balanced and ball bearing. Roof plate, cast bronze, can be bent to any angle. Overall measurements 16 inches by 24 inches.

- No. 124—Sloop (as illustrated).
 - No. 154—Peter Stuyvesant.
 - No. 43—Horse and Carriage.
- Price \$12.50 each.

Warren-Church Weathervane

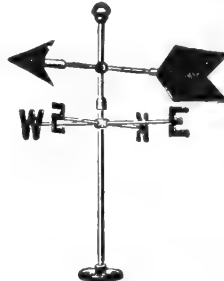

Lower price models with plain arrow figure and points of direction. Made of brass.
No. 1—18 in. wide, 18 in. high, red. . . . \$6 50
No. 2—24 in. wide, 24 in. high, red. . . . 9 50

Bamboo Fernery for House Plants

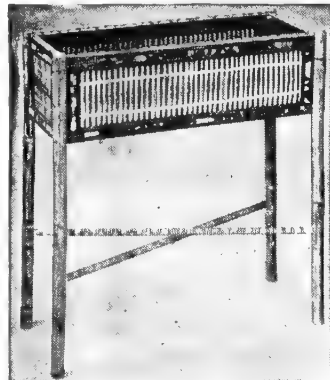

Attractive natural bamboo throughout, ruggedly constructed. Tin pan, with rings for easy lifting out. 28 in. long, 11 in. wide, 7 1/2 in. deep, 30 in. overall height. \$7.50. Packing \$1 extra. Customer pays transportation.

Sundials

Tell the time by the sun! Made of cast bronze, highly finished, and accurate.



No. 226. 7-in. diam. With your choice of inscription, "Time Takes All But Memories" or "Grow Old Along With Me The Best Is Yet To Be." \$6.

No. 258. 9-in. diam. With your choice of inscription, "Time Takes All But Memories" or "Let Others Tell of Storms and Showers I'll Only Mark Your Sunny Hours." \$9.50.

No. 59. 10 1/4-in. diam. With your choice of inscription, "Time Takes All But Memories" or "Let Others Tell of Storms and Showers I'll Only Mark Your Sunny Hours." \$11.50.

Pedestal for any of the above four Sundials \$13.50 each. Crating \$3.50 extra. Customer pays transportation.

Cement Cabin Wren House

Will last a long time. Made of steel-reinforced concrete, rustic finish. 6 3/4 in. wide, 6 in. high. Furnished with steel loop for easy hanging. Bottom removable for easy cleaning. \$5.



Cement Log Wren House

Beautifully shaped into a log with perch. Made of steel-reinforced concrete. Will last indefinitely. 6 in. diameter, 6 1/2 in. high. Furnished with steel loop for easy hanging. Bottom removable for easy cleaning. \$5.

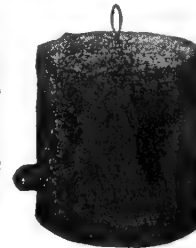

Stump Bird Bath

Made of steel-reinforced concrete. Rustic finish. A unique Bird Bath that harmonizes with natural surroundings. 25 in. high, 18 in. diameter. Weighs 100 lbs. \$18. Crating extra, \$3.50.



Rustic Bird Bath

Made of steel-reinforced cement. Natural rustic finish. Large compartment for water; smaller compartments for food. Diameter of bowl 20 in.; height 31 in.; weight 75 lbs. \$13.50. Also in white birch finish \$27.50. Crating \$3.50 extra. Customer pays transportation.

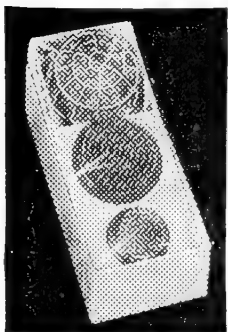

RUSTIC GARDEN FURNITURE

For that secluded rendezvous, your hideaway or any favorite spot in your garden, we offer for permanent installation five pieces of cement composition garden furniture that will thrill you and your gardening friends. Almost natural in effect, strong, and will withstand the elements for years. Rustic bark finish.

Sawco Charcoal Grill

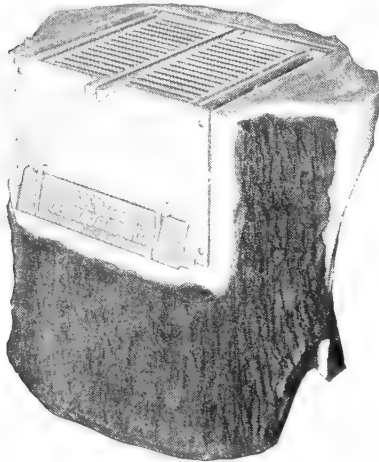

For parks, home-gardens, camps, clubs, and public picnic grounds. Ideal for perfect broiling of fish, steaks, chops, game, and fowl on the conveniently spaced bars of the grill. Will serve up to twenty people very quickly. Made entirely of fine gray stove cast-iron. Completely built into reinforced concrete natural-effect stump. Cooking surface 15 x 15 inches. Both grates swing open for easy feeding of extra charcoal or cleaning out. Over-all dimensions of grill, 18 in. wide, 17 in. deep, 11 in. high. Net weight, grill and stump, 150 lbs. \$60. Crating extra, \$7.50.

Gazing Globe and Pedestal No. 40

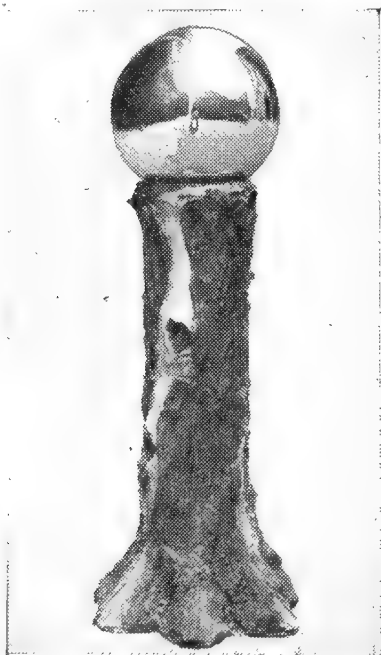

Pedestal made of steel-reinforced concrete. Rustic finish. A treasure you will cherish for years. A rare addition to your garden. 30 in. high, 8 in. diam. Weighs 50 lbs. \$15. Crating extra, \$3.50.

GLAZING GLOBE furnished in the following diameters extra: 8 in. \$5, 10 in. \$7, 12 in. \$10, 14 in. \$13.

Sawco Garden Ensemble (Consists of table and four stools)



Strikingly effective for that favorite spot in your garden. You will really treasure this ensemble. All made of reinforced concrete, rustic finish and valspar fawn color tops. Height of table 30 in. diameter 34 in. Height of stools 17 in. diameter 16 in. Weight of table 150 lbs., stools 25 lbs. Price complete \$75. Can also be purchased individually—Table \$45, Stools \$8 each. Crating extra, \$15.

Sawco Log Bench



Something really useful and attractive in any garden. Made of reinforced cement, rustic finish. Height from ground 17 in., length of seat 40 in., width 12 in. Supported by four legs each 3½ in. in diameter, 14 in. long. Top finished in a beautiful natural grain and valspar for outside protection. Weight 150 lbs. \$22.50. Crating extra, \$5.

Sawco Stump Incinerator



A good cement-composition Incinerator suitable for the home, country or estate. Its rustic bark finish harmonizes with surroundings. Height 36 in., diameter 18 in. Has side openings at bottom for draft and to easily remove ashes. Has strong tubular steel grate. Weight 175 lbs. \$23.50. Crating extra, \$5.

Sundial and Pedestal No. 50

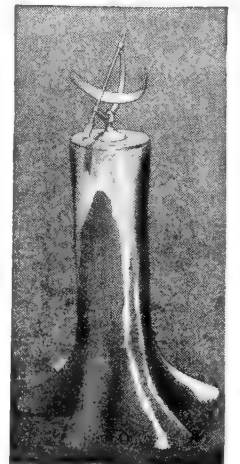

Pedestal made of steel-reinforced concrete. Rustic finish. Here is something unusual you will be glad to possess. Pedestal only 30 in. high, 7 in. diam. Weight 50 lbs. \$15. Crating extra, \$3.50.

SUNDIAL lends itself to use in gardens and landscapes. Hemisphere-like. Made of heavy cast bronze. Designed along the same lines as those used by the ancients. Signs of the zodiac are cast in the bronze base. Special fitted for the pedestal, \$17.50 extra.

Sawco Aluminum Picnic Basket

Made of hand-woven aluminum strips 1 in. wide with lustrous silvery finish. Sturdy and easy to keep clean. Double handles for easy carrying. Hinged cover. Edges of basket and cover reinforced. 15 in. long, 10 in. wide, 11¼ in. deep. \$10.95.

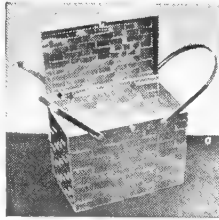

Speedway Sprayer

It's Quick! It's Easy! It's Economical!

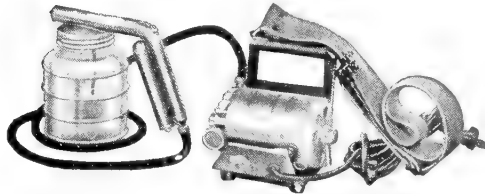

A new electric paint Sprayer. Ideal for reed furniture, metal and wood chairs, window screens, painting the car, etc. 24-oz. glass tank. Spray head is adjustable. Equipped with 4 ft. of hose, shut-off valve and located switch. Weighs less than 4 lbs. 110-120 volt universal motor. Easily adjusted carrying strap. Complete with 10 ft. of electric cord. \$34.95.



Berry Basket Holder

As good as a third hand when picking any of the bush berries, especially tender red raspberries, where the cane must be held in one hand while picking. Basket is placed in clamp near top of staff. Holder is carried along row and thrust in ground near picking spots.

Made of steel, 37 in. high, red enameled. \$1.00. Baskets Extra, 1-qt. size, \$1.00 per doz.



Whippet

Instant Fire Extinguisher, powder form. Good for most all fires. Simply dash handfuls of powder at the flames. Easy to use, instant in effect. 2½-lb. container. \$2.50.

Presto Fire Extinguisher

Take along a Presto, the one-man fire-fighting department. Kills all fires faster than bulky extinguishers many times its size and cost. Small, powerful and light—it's a "must" for camping and picnic trips... or keep it handy in the car. Simple to operate—point it toward the fire, press the valve and PRESTO does the rest. \$3.85. Refill at factory \$1.85.



Super Agricultural Spray

Spray crops by motor power right from your own car, truck or tractor engine. No more pumping by hand. No parts to wear out. Consists of 10-gal. welded steel tank, 24-in. spray nozzles, 66-ft. rubber hose, safety valve and four adaptor fittings for attaching to spark plug opening of any engine with two or more cylinders. Gasoline or oil cannot enter tank. Enables you to spray fruit trees, field crops, whitewash, spray shingles and disinfectants with ease. Develops up to 90 lbs. pressure. Intake valve retains pressure when air hose is disconnected from tank. \$52.50.



TRANS-PLASTIC PAINT—Modern Beauty Long-Lasting Colors

Walls, floors, linoleum, furniture will all be brighter, more attractive and last longer if protected with mar-proof, color-harmonizing Trans-Plastic. Use it inside or out, wherever colorful protection is desired. You'll be amazed at the difference just one coat will make, how it covers and hides in one coat over even old, badly worn surfaces. Mirror-like in smoothness, tough enough for industrial use, yet dainty enough to blend with the delicate

soft colors of the finest homes; provides a new note in modern decoration.

Trans-Plastic does not crack, chip or peel. It comes up gleaming even after frequent scrubbing and hard wear. Its glossy surface resists alcohol, fruit juices, heat, boiling water, and the daily torture of hard wear underfoot.

COLORS

Transparent No. 918 (For Linoleum)

JADE GREEN No. 906

BLACK No. 917

SLATE GRAY No. 913

WHITE No. 916

COLONIAL BLUE No. 905

TILE GREEN No. 911

IVORY No. 902

CANARY YELLOW No. 900

VERMILION No. 907

Pint \$1.25; Quart \$2.00; Gallon \$7.50

ROYAL BLUE No. 910

PAINT BRUSHES (Pure Hogs Hair Bristle). ¾-in. oval 65 cts.; 1-in. flat 75 cts.; 1½-in. flat \$1.25; 2½-in. flat \$2.25; 3-in. flat \$4.50

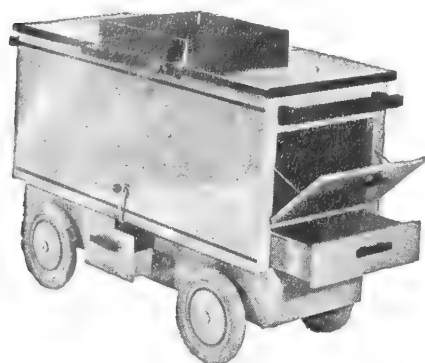

Model No. 20 "The Terrace"

This luxurious model is a perfect unit for outdoor entertaining. All-steel construction, with stainless steel table top. 106 in. of grill surface. In one end there is a beverage cooler, 14 x 14 x 13 in., providing ample room for ice and a continuous supply of cold bottled drinks. At the opposite end, the insulated oven is ideal for baking, and with the door open serves as a warming oven for dishes and rolls. Deep drawer at oven end for accessories. Chrome racks on each side for towels, forks, spatulas. Fire box is designed as a square cone to provide deep fire and for perfection in outdoor cooking. Convenient starting wick. Ash receiver for cleanliness. Unique draft control. 10-in. steel wheels with balloon tires. Baked enamel, beautiful pastel colors. Height 30 in.; length 48 in.; width 20 in. \$175. Spits ensemble for barbecuing, extra, if desired.



Model No. 19 "The Patio"

This modern tea-cart style has 196 in. of grill surface, ample shelf space, stainless steel table top and grill collar, and a warming oven for dishes and rolls. Baked enamel finish in pastel colors for permanent beauty. Handle constructed to fit and support a carving board, which is furnished. Fire box is a square cone for a deep fire and for perfection in outdoor cooking. Convenient starting wick. Ash receiver for cleanliness. Unique draft control. 8-in. steel disc wheels; hard rubber tires. Height 30 in., length 33 in., width 22 in. Weight 45 lbs. \$37.50. Spits ensemble for barbecuing, extra, if desired.



Champion Portable Grill

Blower-type grill produces instantaneous fire at full heat. Need not be turned after starting fire. Easily assembled or taken down in a few minutes. Ideal for all outdoor barbecuing or broiling. All steel construction. Grill 20 in. in diameter. Height to top of grill 35 in. Weight 85 lbs. Mounted on two rubber-tired wheels for easy moving. \$40.



Grilladier Outdoor Grill

Garden grate that puts more fun in outdoor cooking. Made of durable cast iron. Weighs 125 lbs. The entire top rotates easily so smoke can't blow in your eyes. Just the right height for cooking. Ash shelf for neatness and utensil rest for convenience. Base is heavy—can't tip over. Has all the advantages of permanence and yet it slips apart quickly and is easily moved to another location. \$37.50.

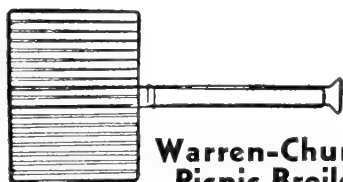

Warren-Church Picnic Broiler

Made of straight steel rods. 12 x 16 in. Length overall 32 in. \$1.75.

Charco Broiler

The handiest and sturdiest portable Charcoal Broiler made. Uses a very small amount of charcoal. Easily assembled. Legs fold back to 17 in. for use in open fireplace. Equipped with draft. Conical body of baked-on ceramic, won't fade, rust or burn off in any weather. Overall height 30 in.; cooking surface 16 in. across. \$12.



Portable Picnic Grill

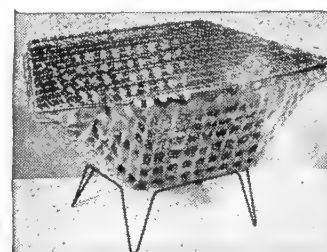

Body made of mixture of asbestos and glass, highly heat resistant. Can be used as a Grill or refuse burner. Steel wire legs and broiler easily removable. Body measurements 20 in. long, 12 in. wide, 7 in. deep, overall height 10 1/2 in. \$3.50.

Master Deluxe Grill

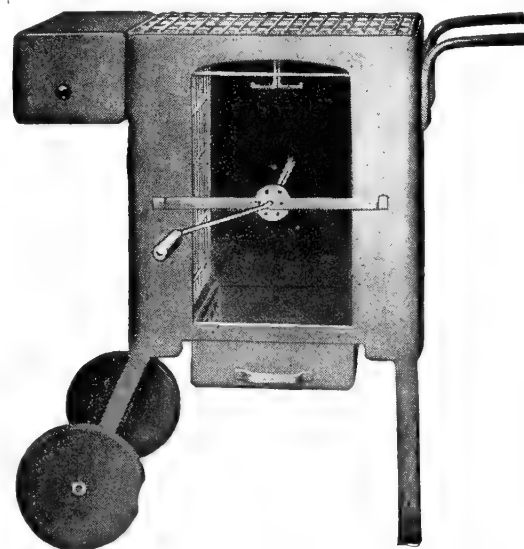

Complete with wheels and adjustable legs. Meats are broiled without burning or smoking between movable fire compartments, one on each side. Sliding drawer for ashes. Quickly interchangeable with long handled wire broiler. Has Bun Warmer and Warming Shelf. 32 1/2 in. high, 32 1/2 in. overall width at top, 13 1/2 in. deep. Price—complete with revolving spit and long handled steak broiler \$37.50.

Sawco Portable Picnic Table

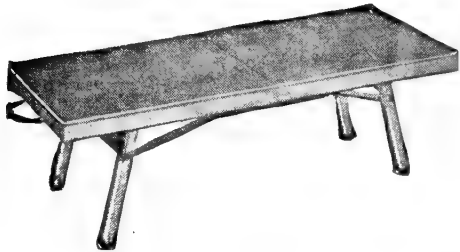

A unique, practical Picnic Table smartly designed and solidly constructed. For camping, by the grill, on the boat, at the beach and as a bed tray table you will find it invaluable. A "must" for automobile equipment. Completely collapsible, light and easy to carry. Made of high quality polished veneer. Off the ground, away from dirt, sand and crawling things of nature. Small size, folded 15 x 16 x 2 3/4 in.; open 16 x 34 in. \$6.95. Large size, folded 17 x 24 x 2 3/4 in.; open 34 x 24 in. \$7.95.

Warren-Church All-Steel Table

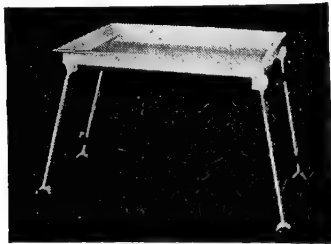

Finished in white enamel. Has folding legs; removable tray. Size of tray 21 x 16 1/4 x 1 1/8 in. deep. Folded flat 21 x 16 1/4 x 3, set-up 17 in. high. Weighs 25 pounds. A very sturdy Table that can support tremendous weight. Individually cartoned for storing. \$7.50.

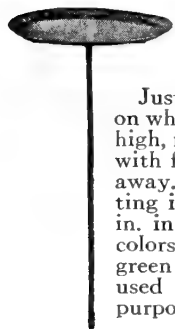

**Tray-Table
"Lawn Cocktail Tray"**

Just the thing to put that drink on when your hands are full. 23 in. high, made of 5/16 in. square steel rod with fold-over top for easy storing away. Ideal for picnics and putting in your car. Metal tray 9 1/2 in. in diameter. Set of 3 in solid colors of red, blue, and orange, green painted stakes. Trays can be used all year round for many purposes in the home. \$3.95.

**Sunday
Nite Chef
Griddle**

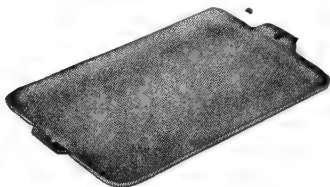

The new Magnesium Griddle—19 in. long x 12 in. wide. Weighs only 8 ozs. Fits over two burners, giving even heat over entire cooking surface with small fuel consumption. Ideal for Pancakes, French Toast, Frankfurters, Hamburgers, Eggs, Bacon, etc. \$3.75.

Barbecue Apron

Made of durable material with adjustable straps at neck and waist, and also has a loop for a towel at the belt. Large, handy pockets for cigarettes and matches, at the same angle as a man's trouser pocket. \$2.95.



Barbecue Mitts

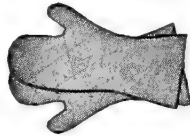

Built high to protect the arm, and padded with heat-resisting asbestos. A small handy loop is placed at the top of the mitts for hanging up when not in use. \$2.

Bar-B-Q Set



A beautiful three-piece stainless steel set with maple polished wood handles. Built to last a lifetime. All pieces approximately 21 in. long. Consists of two-tine Fork, Spatula, and Lobster Tong. Set \$4.50.

Trio Set

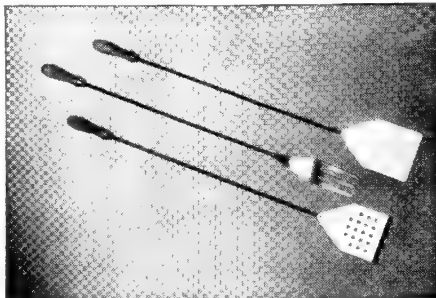

Consists of three pieces: a Spatula, a 3-prong Fork and a Griddle Scraper. Ends all made of Stainless Steel, attached to wrought iron rods, with wooden handles. Each piece measures 29 in. long. \$3.75, set complete.

Wrought Iron Grill

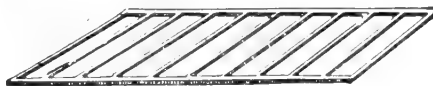

Well made. Can be used for permanent stone or brick fireplace. Made of 3/8-in. square iron. 24 in. long, 18 in. wide. \$7.

Sawco Picnic Kit

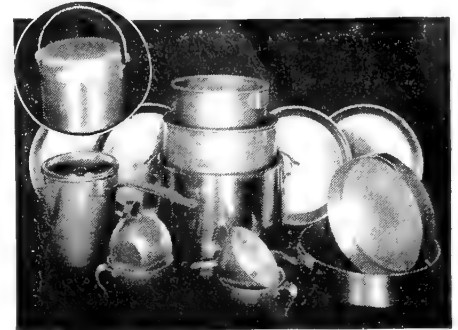

Fourteen pieces of sturdy Aluminum nested into one light, compact unit. Consists of 4 Plates, 4 Cups, 2 Stew Pots, 1 Bucket, 2 Frying Pans and 1 Coffee Pot. Weighs only 5 1/2 pounds. Overall size 9 in. high, 7 1/2 in. in diameter. This is really a combination that is ideal for any picnic. All pieces light weight, easy to clean, resistant to rust and cannot chip or break. \$10.50.

Ford Charcoal Briquets

Charcoal in its purest form. Compact, pillow-shaped bricks manufactured under tremendous pressure. Even lighting, hottest burning. No sparks or flames. Leaves no ash. 20-lb. bag \$1.85.



Pronto Fire Kindlers

For quick starting of wood and charcoal fires. Simply place one or two kindlers in bottom of fireplaces, campfires, stoves and grills, and light with match. Not subject to moisture—burns well even when wet. Each Kindler burns for 15 minutes. Also ideal for emergency lights and flares. Box of 12, 35 cts.; 5 boxes or more, 25 cts. per box.



Mira-Gril

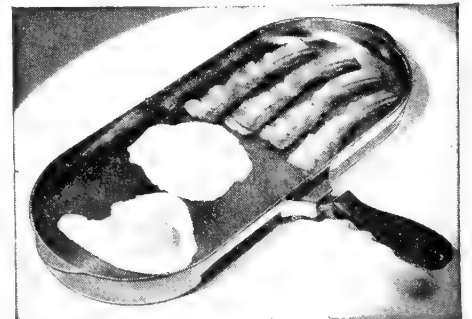

It's a Griddle! It's a Skillet! It's a Roasting Dish! It's a Sizzling Platter! Can be used indoors or outdoors. Ideal for making griddle cakes on one side and as a roasting dish on the other side. 8 3/4 in. wide x 19 in. overall. Thermoplastic handle furnished, detaches very easily. Made of pressure-molded cast aluminum. Fast heating. \$5.95.

Portable Spit



Made of wrought iron. Can be placed over bricks, stones or your own grill. 20 in. long, 8 in. wide, 8½ in. high. Length of Spit 24½ in., overall 33 in., with wood handle. \$7.75.

Streamliner Freezer

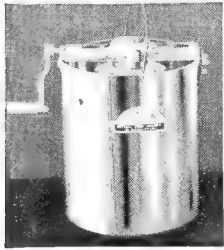

The newest in Freezers. All aluminum construction. Guaranteed pure and safe for health. Four-quart capacity. Height 12½ in.; diam 10¼ in. Made to last a lifetime. Will not rust or corrode. Makes ice cream in five minutes, also delicious lemon and orange ices. You really can't be without one this summer. \$12.95.

Silver Queen Ice Cream Freezer

Makes ice cream the easy way—no long hand turning to tire you. Also ideal for making fruit ices. Uses the packed in ice with salt method; makes one gallon. Powered by 170-watt induction motor AC 115 volts 50-60 cycle. Underwriter's approval. Instructions and recipe folder included. (July Delivery). \$24.95.



Thermaster Picnic Jug



A modern, streamlined, unbreakable Picnic Jug. Smaller, lighter and easier to carry than the old-fashioned jugs, but still has a one-gallon capacity. All metal liner, surrounded by a wall of fibre-glass insulation, and jacketed in a steel body finished in a gun-metal baked-on enamel. The cover is of bakelite. Has two plastic cups under cover. A patented fold-away spigot is an added feature of this Jug. \$6.95.

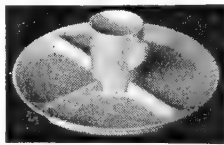

Picnic Plate and Cup

Made of plastic. Combines 10½ in. Plate and 6 oz. Cup. Cup non-slip, non-skid base and stay cool handle. Plate ridged for separation of food. Odorless, tasteless, non-inflammable, non-toxic, color fast. May be washed in hot, soapy water. Do not use harsh abrasives. Color cherry-red. Plate and Cup, \$1.25. Tumbler is optional or can be bought separately for Picnic Plate and Cup. Ideal for serving iced tea, iced coffee, cocktails, etc. Notched non-skid, non-slip base 4¾ in. high; 3¾ in. flared lip. 50 cts. each.

Snack-Master Trays

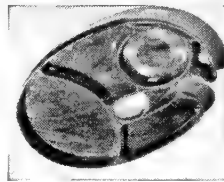

Molded of unbreakable, washable plastic. Shaped like an artist's palette, with thumb-hole and partitions for food, dessert, beverage and napkin. A perfectly balanced lustron tray for parties, picnics and teas. Very handy; don't be without them. Set of four in fiesta colors, \$2.00. Extra trays, 50 cts. each.



Bug-Chaser Lamps

Now! Make your summer evenings more enjoyable. Made of special yellow glass that reduces the attraction of phototropic insects by as much as 92%. Reduces the nuisance of mosquitoes, gnats, flies, and other insects. Remarkably free from glare, yet highly efficient in its illumination. 60 watt 30 cts., 75 watt 40 cts., 100 watt 50 cts.

Howe Fireplace Grate and Barbecue Grill

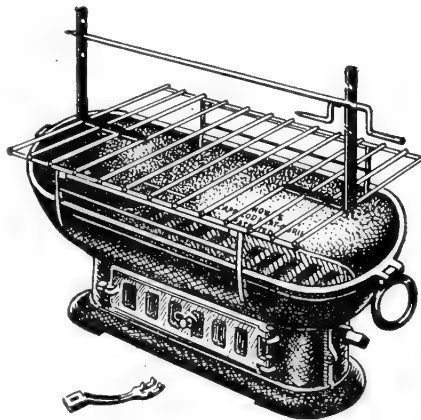

All cast-iron construction. In the winter can be used as a fireplace grate and in the summer as a grill and barbecue. 24 x 12 in. wide, 9 in. high. Can be carried in car. Burns coal, wood or charcoal. Has easy dump grate with fully enclosed ash pit. Draft-control doors assure uniform heat for comfort or for cooking. Weight 40 lbs. Complete with spits ensemble. \$22.50.

Hickory Barbecue Flak



For a thrill in barbecuing you want hickory smoke. It tastes so good because the flavor is in the smoke. A "must" for outdoor cooking. Simply add them to your charcoal or wood fire. Give that tangy, old-world flavor to meats, fish and poultry. Makes them burst with luscious goodness. A cooking thrill without muss or bother. 2½-lb. bag \$1.00, 40-lb. bag \$7.50.

Hot-R-Cold Pak

Four minutes in hot water . . . it's a hot pak. Place it in your refrigerator and it becomes a cold pak. Made of vinylite plastic. There are three separate compartments that contain chemical fluid. Completely flexible and it only weighs 16 ozs. Complete with carrying case and full directions. \$2.00.

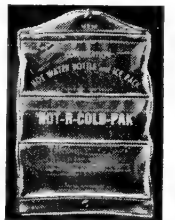

No. 30. Kabob Skewer



Stainless Steel with Wooden Handle. Complete with disc to remove meat. Ideal for cooking Shishkebab, Shashlick, Beef Kabobs, Frankfurters, Marshmallows, etc. 26 in. overall. \$1.50.

Come and Get It

by George Martin. The complete outdoor chef. Outdoor cooking and eating ideas that will fit all kinds of gatherings. Hundreds of recipes that have been tried and tested, including fish and game. Ideal for sportsmen. Also contains important information for the building of temporary and permanent fireplaces. 183 pages. \$3.00

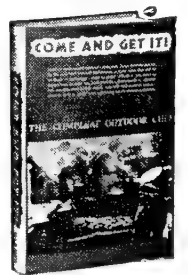

Barbecue Book

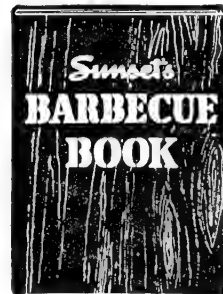

Barbecuing (with grill, outdoor fireplace, or both combined) is the growing home sport of America. Tells you how to locate a barbecue on your lot, gives you dozens of actual designs to choose from. Contains scores of appetite-whetting recipes and menus. Illustrated, 76 pages, \$1.50.

Sawco Fold-a-Chair



A 3-position reclining arm chair. Gleaming polished Aluminum tubing, Aluminum arm rests, canvas seat and back—impervious to rain. For porch, beach, lawn, boating, etc. Folds and sets up very quickly. 18 in. x 18 in. seat, 31 in. high back. Folds to 27 in. x 41 in. for easy transportation or storing. Weighs approximately 6½ pounds. Furnished in blue, green or maroon canvas—specify color when ordering. \$14.75.

Portable Picnic Refrigerator

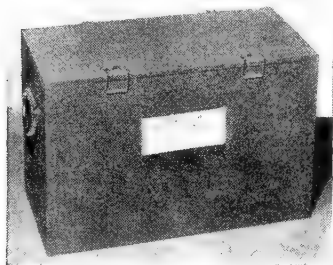

Ideal for the picnicker, sportsman and for home, farm and trailer. Fully insulated, removable watertight ice container. Fold-away hinged cover. Easy grip handles. Interior baked white enamel finish. Exterior green wrinkle baked enamel finish. Utilizes either dry or regular ice. No. 10. 17 x 8½ x 11½ in. Weighs approximately 10 lbs. \$6.00. No. 15. 21¾ x 10½ x 14½ in. Weighs 20 lbs. \$9.95.

Lamplighter

A super outdoor fluorescent light. Remarkable brilliance. Easy-to-grip carrying handle. Convenient push and pull switch. Plexi-glass non-shatterable window. All aluminum construction. Fluorescent tube good for 1000 hours of light. Uses portable 45-volt "B" batteries; average life 50 hours. Functional design; nothing to rattle or shake. Compact size: 4¼ x 7⅞ x 9 in. Turns night into day the modern way. For fishing, boating, picnicking and many other uses.

Don't be without one. Complete with batteries and tube, \$9.75.



Kasson Electric Bar-B-Q

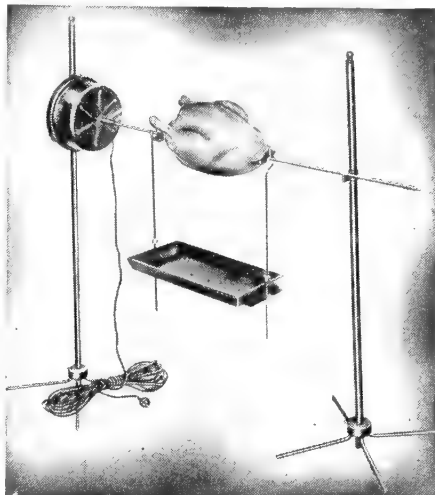

At last—a barbecue without tedious hand turning. Power driven, revolves three times per minute. Meat cooks evenly and fully without burning. Operates on house current; motor is self-starting. Height and width adjustable—can be set as high as 48 inches and as low as 24 inches. Extra set of short uprights included for the indoor fireplace. Has holders for drip pan, allowing meat to be basted in its own juices. Steel spit 48 in. long. Enjoy the thrills of barbecued meat, poultry, fish cooked in a most modern and pleasant way. \$39.50.

Roto-Master

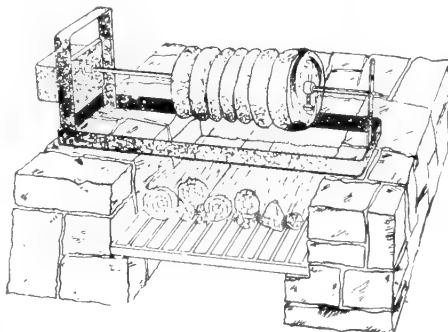

A sturdily constructed electric spit (rotisserie) which will turn up to 20 lbs. of meat or fowl at 4 rpm. Operates at 110 volts a.c., uses only 15 watts. Can be used with any grill or fireplace indoors and out. Adjustable to three different heights. Two adjustable skewers hold meat securely in place. All steel construction. Delightfully entertaining for family and guests. \$24.95.

Foot Scraper



This little Dachshund Foot Scraper adds a friendly touch to your door. He weighs 30 lbs. and is 22 in. overall. Solid cast iron; body velvet black, tongue red. \$9.50. Packing 50 cts. extra. Customer pays transportation.

Vinylite Plastic Mattress

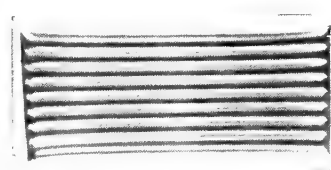

Same construction as the Vinylite cushion. Ideal for swimming, camping, sun bathing and home use. Size 24 in. wide x 72 in. long. Quickly inflated rustproof Schrader air valve. Any color; please state your choice. \$15.00.

Vinylite Plastic Cushions

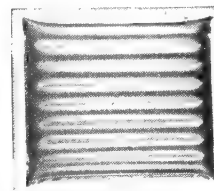

Made of new Vinylite. Waterproof and rot-resistant. Will not crack or become sticky. Welded airtight seams. Ideal for outdoor furniture seat, automobile pillow and many other uses. Quickly inflated dustproof Schrader air valve. Red or green. Size 15 x 15 in. \$3.00.

Vinylite Plastic Tablecloth

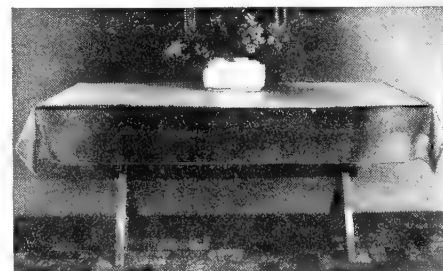

Made of Vinylite plastic, waterproof, rotproof. Will not crack or become sticky. Ideal for picnics and camping. Can also be used to cover anything left out in the rain. Translucent green, red, or clear. Size 36 x 72 in. \$2.50.

Lucky Horseshoe Bell

At your garden gate, house, camp, or as a "come and get it" call. Unique, attractive, practical. Two old horseshoes welded so they chime pleasantly when tapped with rawhide-tied clapper. Black weatherproof finish. Height 9 in., diameter 8½ in. Complete with horseshoe bracket. \$9.50.



Poker Chip Set
(Genuine Catalin)



A Chip Set to be proud of. Contains 200 chips, white, blue and red. Made of genuine mottled catalin, including the case and knob. Length 7 1/4 in., width 4 1/8 in., height 3 1/4 in. Weight 3 3/4 lbs. Case in either red, green or onyx. Complete with two decks of fine-quality flower-design Congress playing cards. \$10.50.

Gin Rummy Set No. 692



A fine set made of top-grain cowhide leather. Complete with walnut wood, specially constructed, self-stacking, two-section tray, hand rubbed and polished. Size, 5 7/8 in. long, 6 in. wide, 1 1/2 in. deep. Contains one deck of fine-quality gilt-edge playing cards, gin rummy score pad, pencil and instructions. \$6.50.

Chip and Card Set No. 661



Top-grain cowhide leather case. Drop front. Complete with 100 7/8-in. interlocking, unbreakable plastic chips and one deck of fine-quality gilt-edge playing cards. Size 4 in. long, 2 1/2 in. wide, 2 in. deep. \$4.25.

All-Game Set No. 1100



Here is a combination game outfit of rich English genuine tan leather. A magnificent presentation. Eight games in one, and every one a popular favorite. Checkers, chess, backgammon, acey ducey, 100 poker chips, set of 5/8-in. poker dice, set of 5/8-in. regular dice and a deck of fine-quality gin rummy cards. Contains wood playing board for chess and checkers on one side and backgammon and acey ducey on reverse side. Complete with plastic playing pieces and backgammon doubler. Traveling size, 7 3/4 x 5 1/4 x 1 3/4 in. deep. \$15.

Gin Rummy Special No. 810

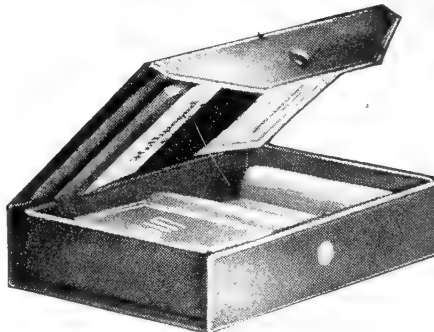

Smartly constructed of rich simulated pin seal leather. It contains a Gin Rummy rack, score pad, and a deck of fine-quality gilt-edged playing cards. Size 6 1/2 x 4 1/2 in. Name of game richly stamped in leather. \$3.

Backgammon Set No. 805

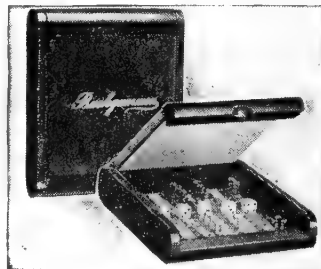

The game that will never lose its popularity. Complete with plastic playing pieces, set of dice, and unique Backgammon doubler. Genuine top-grain cowhide cover and walnut-finished frame. Pocket size, in smart gift box 4 1/2 x 5 1/2 in. Name of game richly gold stamped in leather. \$3.50.

Dice and Cup Set
No. 1311-656



Consists of English leather cowhide cup 3 3/4 in. deep, 3 in. in diameter, felt-lined with special trip rim, five 5/8-in. catalin regular dice and five 5/8-in. catalin poker dice, in cowhide leather case with snap-on button fastener. \$4.25 per set.

Checker Set No. 801



The game all America loves to play. Genuine plastic playing pieces which may be inverted for crowning kings. Genuine top-grain cowhide leather cover and walnut-finished frame. Pocket size, in smart gift box 4 1/2 x 5 1/2 in. Name of game richly gold stamped in leather. \$3.50.

Pitching Horseshoes

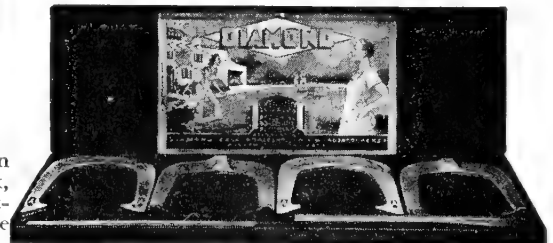

Approved by the National Horseshoe Pitchers' Assoc. Drop forged heat treated to prevent chipping or breaking, without destroying dead falling qualities, perfectly balanced for easy control. Each set consists of four shoes and two steel pointed stakes. Two shoes painted aluminum, and two gold. Weight per shoe, 2 1/2 lbs. \$10.50 per set.

"Say When" Liquor Pourer

Fits top of any liquor bottle. Press down and you will have exactly one ounce in your glass. Press once again for a double dose. Chrome plated. \$3. 24 Kt. Gold Plated, \$5.

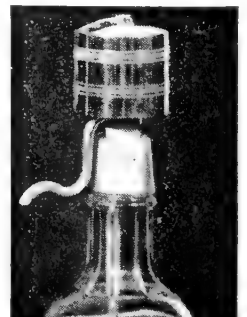

INSECTICIDES, FUNGICIDES, ETC.

NOTE: On orders for Insecticides and Fungicides over \$3 in value, we prepay to points within 50 miles of New York City. Freight or Express, our option. If value of order is \$3 or less, or if shipment is made beyond 50 miles of New York City, customer pays transportation charges. We send by express items not mailable.

SYNDEET

(DDT LIQUID SPRAY)

An improved insecticide containing 30% DDT. It will control aphids, thrips, and European red mites and, in addition, all potato insects, codling moth, Japanese beetles, boxwood miners and other insects controlled by DDT. Eight ounces will make 48 to 72 gallons of spray, as directed.



RETAIL PRICE

½-pt. bottle. \$1 00
1-qt. can 3 00
Gal. 8 00

UNXLD 448 Insect Repellent



Repels mosquitoes, gnats, fleas, chiggers and many other insects. One application good for 6 to 10 hours. Simply spread liquid evenly over all exposed areas of the skin. Keep away from eyes and lips. Garden in comfort, fish with pleasure, picnic in peace, enjoy relaxation. A post-war discovery. 2-oz. bottle 69 cts.



STUN

The new insect repellent for mosquitoes, gnats, sand flies and related insects. Formulated by one of the foremost chemists of the country. Greaseless white liquid. Apply to exposed parts of body. Repeat often. 2-oz. bottle 35 cts., \$3.50 per doz.



TUFOR

A concentrated 2,4-D selective weed killer. Four ounces treats 3,250 sq. ft. of lawn to control dandelions, plantain and other unsightly weeds. Also controls poison ivy, honeysuckle and many other noxious weeds.

4-oz. bottle.....\$1 00
1-pt. bottle..... 2 00
1-qt. bottle..... 3 50

ROTENE ROTENONE-THIO-CYANO SPRAY

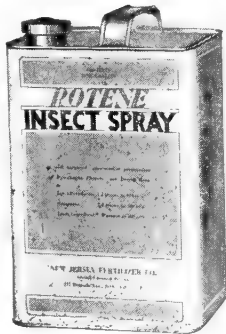

ROTENE INSECT SPRAY. Non-poisonous, rotenone-thio-cyano-spray. Harmless to fruits, vegetables, and flowers, humans and animals. For chewing and sucking insects. A teaspoonful to 1 gal. water, 1 oz. to 8 gals. Oz. 35 cts., 4-oz. bottle \$1, pt. \$2.50, qt. \$4, gal. \$13.50.

AMMATE Kills Poison Ivy

One Application Does The Job!

Use 1 lb. per gal. of water sprayed over 100 sq. ft.

Du Pont Ammate Weed Killer makes it easy to kill poison ivy for keeps. Just mix with water and spray on. Kills foliage, roots and all. Kills poison oak, sumac and other tough weeds. 2 lbs. 85 cts., 6 lbs. \$2.25, 50 lbs. \$12.00, 350 lbs. \$63.00.



SAWCO-JAPY

(Japanese Beetle Milky Disease Spore Dust)



Destroys the larva or grub of the Japanese Beetle which causes severe injury to turf in lawns, golf courses, parks, pastures and gardens.

The bacteria causing the "milky disease" are *Bacillus Popilliae* and *Lentimorbus*. Sawco-Japy (milky

disease spore dust) contains at least 100 million viable spores of either or both of the above organisms per gram of product.

Thoroughly mix one pound of Sawco-Japy with two pounds of coarse sand or dry soil and apply this mixture uniformly over 4000 sq. ft. Brush or water into soil immediately after application to prevent loose dust from being picked up by the wind.

½lb. (sufficient for 2000 sq. ft.) \$2 75
1 lb. (sufficient for 4000 sq. ft.)..... 5 00

TAT C-LECT KILLS CRABGRASS

Without Harming
Delicate Turf!

Now you can kill crabgrass *selectively*—with perfect safety to your lawn! Merely spray on TAT C-Lect TATC-Lect is an effective fungicide, too. Your lawn grasses grow to a new and healthy green. Quickest crab grass control when applied to seedlings. Start early and have a beautiful lawn all summer. Use four teaspoonfuls to a gallon of water over 100 sq. ft. 8 oz. bottle 85 cts., 16 oz. \$1.50, gal. \$9.75.



INSECTICIDES, FUNGICIDES, ETC.

NOTE: On orders for Insecticides and Fungicides over \$3 in value, we prepay to points within 50 miles of New York City, freight or express our option. If value of order is \$3 or less, or if shipment is made beyond 50 miles of New York City, customer pays transportation charges. We send by express items not mailable.



Use SYNKLOR

New Chlordane Insecticide, for a fast, effective kill.

Synklor-50-W-Wettable Powder

| | |
|----------------------|--------|
| 8-oz. container..... | \$1 50 |
| 1-lb. container..... | 2 75 |
| 5-lb. container..... | 8 50 |

Synklor-48-E-Liquid

| | |
|---------------------|--------|
| 1/2-pt. bottle..... | \$1 50 |
| 1-qt. bottle..... | 5 00 |
| 1-gal. can..... | 13 80 |

MAGI-KIL

The Original Jelly Ant Bait



Clean, odorless and easy to use. Works satisfactorily indoors and outdoors.

MAGI KIL is unusually effective because it contains Thallium Sulphate, which is tasteless to ants. The worker ants carry the jelly back to the nest, thus killing the queen and the entire colony.

For general applications use tubes. In the presence of children and pets, use traps.

| | | | |
|-----------------|-------------|-------------------|-------------|
| Traps..... | Each \$0 25 | 3-oz. tubes.... | Each \$1 00 |
| 1-oz. tubes.... | 40 | 7 1/2-oz. tubes.. | 1 95 |

Mosquito Larvicide

What! No mosquitoes? Exactly. A startling discovery that will keep mosquitoes away from three to five hours, depending on the weather conditions.

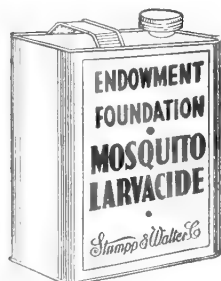

A liquid preparation that is absolutely safe and harmless to yourself, pets and plants. Simply dilute it one part to nine parts water and spray it on your lawns, shrubs and plants. Enjoy your garden outdoors without annoyance from mosquitoes. Gal. can \$2, 5 gals. \$8.50.

PESTMASTER 3-in-1 Rose Treatment

No More Messy Mixing!
Easy—Economical—Resultful



Try this new, easy way to lovelier, longer-lasting blooms. Contains everything you need for insect and fungus control on roses, azaleas, peonies other flowers and ornamentals. Contains DDT, rotenone, copper and sulphur, all blended into one formula for easy mixing... you just add water.

KILLS rose chafer, Jap beetles, aphids, red spider; CONTROLS black-spot, leaf rust, powdery mildew. 1-lb. can makes 32 quarts of spray, enough for season's treatment of 24 to 40 plants at cost of only 6c per plant!
1-lb. can.....\$1 75

NOXWEED

Kills All Vegetation

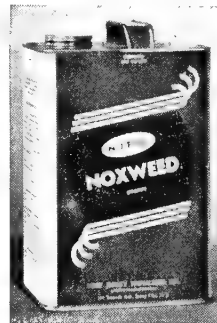

NOXWEED. Contains 5 pounds sodium arsenite to the gallon. Satisfaction guaranteed. May be applied by means of watering can, sprayer or sprinkling barrel. Harmless to stone, woodwork, or shoes. One thorough application will kill all weeds. One gallon diluted 1 part to 40 parts of water will cover 100 to 150 square yards of space. Qt. 85 cts., gal. \$2.50, 5 gals. \$10.00, 10 gals. \$18.50, 30 gals. \$40.50, 55 gals. \$65.00.



MOLEFUME

Molefume. A non-poisonous cartridge that liberates a deadly smoke. Very effective against moles, rats, gophers, woodchucks, hornets and wasps. Non-injurious to vegetation. Harmless to humans and pets. Use one cartridge every 15 to 25 feet. Box of 6 cartridges \$1.50, 5 boxes \$7, 10 boxes \$13.

KILL MOSQUITOES

OUT-DOORS

Relax

In Comfort—Free from the Misery Caused by Mosquitoes

"Black Leaf" Mosquito-fumer

4872

THE OUTDOOR MOSQUITO KILLER

Easy
to use—Easy as pointing a Hose

Acts like magic. Rids the premises of the pests in a few minutes' time. Not a repellent—it really KILLS mosquitoes—and their larvae, too.

Just light a Black Leaf Mosquito-fumer and let its mosquito-killing fumes drift into shrubbery and other lurking places of these tormentors. Brings pleasant relief for several hours. One can treats an average city lot. Three cans treat an acre.

6 oz. can, 45 cts.,
\$5.25 per doz.

HORTEX



HORTEX. The new rotenone contact and stomachic insecticidal dust combined with colloidal sulphur to preserve it and lengthen the period of insecticidal efficiency. It is non-poisonous. Used for the control of many fungous diseases and chewing and sucking insects. A dust unsurpassed for its effectiveness. Contains 1 per cent rotenone. Lb. 50 cts., 5 lbs. \$2.00, 25 lbs. \$8.00, 100 lbs. \$27.50.

Postage
Will Be Paid
by
Addressee

No
Postage Stamp
Necessary
If Mailed in the
United States

BUSINESS REPLY ENVELOPE

First Class Permit No. 1373, Sec. 510, P. L. & R., New York, N. Y.

STUMPP & WALTER CO.,

132-138 Church Street,

(Corner of Warren Street)

NEW YORK 8, N. Y.

SPECIAL TULIP BULB OFFER *for Advance Orders*

RECEIVED UP TO AUGUST 1

EXHIBITION COLLECTION: Darwin, Breeder and Cottage Tulips

Without exception no May-blooming bulbous plant rivals the Tulip for its brilliance of color and its adaptability to thrive in the shrubby border, perennial border or formal beds. Creating a lovely garden with Tulips is like painting a picture. And the difference between the hesitant amateur and the finished creator of garden pictures is likely to be the same difference that separates the beginner in painting and the finished artist.

Tulips may be used by the amateur very successfully to obtain color harmonies with many of the most beautiful spring-flowering perennial plants such as the tall bearded Iris, the blue tones of spring Veronicas, Phlox divaricata, Mertensia virginica, blue Aubrieta, and the white Arabis or Iberis, or the orange tone of Siberian Wallflower. Vivid pink Tulips look well against the deep blue lilacs in the shrubby border; the vivid scarlet ones may be planted in clumps of ten to twenty-five against the light and deeper green of evergreen plantings. They make May a delightful beginning to your garden year.

TEN EXHIBITION TULIP VARIETIES

The following ten varieties are considered by Tulip experts to be without a peer in their respective colors for garden planting.

BELLE JAUNE. (Cottage.) For size, depth of color, strength of stem, this is one of the best rich golden yellow Tulips, if not the best. Height 30 inches.

BLUE PERFECTION. (Darwin.) Bright blue-violet, of excellent size, borne on strong stems. The petals have a very artistic appearance, differing from most Darwins in being pointed and slightly reflexed. Blooms with the early Darwins and remains in good condition throughout the Tulip season. Slightly fragrant. Height 30 inches.

GLACIER. (Darwin.) Among the very best of all white Tulips. A flower of largest size when well grown. Has a long season of bloom and is of excellent substance. Height 30 inches.

INDIAN CHIEF. (Breeder.) A huge flower of wonderful substance and most artistic shape, carried on a very long, strong stem, usually 6 inches taller than the best new Giant Breeder varieties. A color unlike any other Tulip, best described as a reddish mahogany edged warm brown. A leader at all Tulip exhibitions. Height 36 inches.

MARJORIE BOWEN. (Cottage.) A very unusual shade—a combination of buff and salmon, which passes to deep rose-pink with salmon shading. The large, well-formed flower is borne on a fine strong stem. Splendid for exhibition; much admired on account of its lively color. Height 29 inches.

MARSHALL HAIG. (Cottage.) Among the new Tulips this ranks as one of the most brilliant scarlets, with a bright yellow base. A flower of magnificent size and texture, much admired on account of its color. We consider this the best brilliant scarlet hybrid Tulip of recent introduction. Height 30 inches.

PRIDE OF ZWANENBURG. (Darwin.) Salmon-pink with a narrow margin of bluish rose. The large flower is carried on a strong, stiff stem. One of the finest pink Tulips, of great substance and especially recommended for exhibition. Height 30 inches.

TANTALUS. (Breeder.) Much praised at all exhibitions on account of its fascinating color. Large, cup-shaped flower of excellent substance, of light cadmium-yellow overlaid with dull slate-violet. Height 30 inches.

THE BISHOP. (Darwin.) One of the outstanding Tulips at most exhibitions and conceded the finest in its class. Best described as the purest heliotrope shade in the Darwins. A large, bowl-like flower of very artistic coloring. Height 30 inches.

THE PEACH. (Darwin.) Without a doubt, this is the finest peach-pink Tulip that has been introduced to date. The color is an even tone of peach-pink. The flowers are large, of splendid substance, and are borne on strong stems; when grown indoors, the color is very beautiful. It blooms with the early Darwins and remains in fine condition with the later ones. Height 30 inches.

Any of the above 10 varieties of Tulips, if ordered separately, 10 bulbs \$1.50, 100 bulbs \$12

SPECIAL COLLECTION OFFER FOR ADVANCE ORDERS

50 Bulbs, 5 each of the above 10 varieties, \$5.50; 100 Bulbs, 10 each of the above 10 varieties, \$9.50

OUR AUTUMN CATALOGUE READY AUGUST 1

High Quality Bulbs for Autumn Planting

Forty-eight pages featuring in color a list of the finest varieties of American, Dutch, English and French flower bulbs. Also perennial plants and sundry items for your garden and greenhouse needs.

PRINTED
IN
U.S.A.



1948 SUMMER CATALOGUE

SEEDS · BULBS
GARDEN SUPPLIES
EPICURE FOODS

Stumpp & Walter
132-138 Church St. (at Warren St.)
NEW YORK 8, N. Y.
New York Phone: BArcley 7-1110
Return Postage Guaranteed

SECTION 562, P.L. & R.

U. S. POSTAGE
PAID

HARRISBURG, PA.
PERMIT No. 84

U.S. Dept. of Agriculture (Library)
Attn. Librarian
Washington 25 D.C.

SR
45

GLADIOLUS *Pre-Cooled Bulbs*

May be planted from now until July 10

Many of our patrons desire Gladiolus bulbs for September blooming. In the neighborhood of New York they should be planted from now until July 10. Order the bulbs immediately; we reserve them and place them in our cold-storage warehouse.

Any good garden soil will grow Gladiolus well, provided they are planted in a sunny location. Bulbs should be 4 inches deep and at least 6 inches apart; frequent cultivation with a hoe or a weeder, around the base of the plant, is advisable. For best results, we recommend plants being staked when a foot high. Water copiously, and as the flower buds begin to form, apply liquid manure for exhibition spikes.

We offer below a selected list of varieties of this popular garden flower. We can supply these bulbs in six separate colors, as well as a mixture of all colors.

COMMANDER KOEHL. Large, brilliant scarlet-blood flowers on a tall stem. Fine exhibition sort and one of the best reds. \$1.00 for 10, \$7.50 per 100.

MAID OF ORLEANS. The pure white florets have cream throats. Many florets in bloom at once. Excellent for exhibition. \$1.00 for 10, \$7.50 per 100.

MINUET. The blooms are of beautiful clear, light lavender, with four to six large, heavily textured blooms open at one time. Late. \$1.00 for 10, \$7.50 per 100.

PELEGRINA. One of the finest dark blue-violet varieties ever introduced, with large individual florets. \$1.00 for 10, \$7.50 per 100.

PICARDY. The individual flowers are delicate apricot-pink, extremely large, somewhat ruffled, and of heavy, wax-like substance. \$1.00 for 10, \$7.50 per 100.

YELLOW EMPEROR. The florets are self-colored, and about the same hue as King Alfred daffodil; handsome spikes. \$1.25 for 10; \$10 per 100.

AMERICAN HYBRIDS MIXED. Contains all the colors available in the flower. The popular price warrants liberal planting. Well matured and good; excellent for cut-flower purposes and mixed borders. 75 cts. for 10, \$6 per 100, \$55 per 1000.

GLADIOLUS THRIPS

A destructive insect of microscopic size causing a silvered appearance on the foliage, drying of the flower-buds, and a general blighting of the plant.

Gladiolus corms obtained from us have been treated to control thrips. On their arrival, however, we recommend:

Before Planting

1. Remove the skins, so that "bare" corms are planted. Do not injure the tips.
2. Stir 2½ ounces of Semesan in one gallon of water. Immerse the corms in the liquid for seven hours; dry and plant.

During Growth

3. Spray with Gladiolus Thrip Spray. Dissolve one pound in 10 gallons of water and apply every two weeks.

When Bulbs Are Lifted

4. In autumn, burn the tops cut from the lifted corms. Place corms in a low, but not freezing, temperature for six weeks.
5. Next cover with paper, first dusting through them one pound of Thripco to each 1000 corms; or you may use Naphthalene Flakes. Avoid containers with close-fitting lids; ventilation is necessary.
6. At the end of one month, shake out the Thripco or Naphthalene Flakes, and store the treated corms in the usual way.

